

Mean Well Power Supplies & Transformers

Power Supplies and AC Transformers Product List

Alpha Power Systems

18/30 Heathcote Road

Moorebank NSW 2170

T (02) 9602 8331

F (02) 9602 9180

E admin@alphapower.com.au

W www.alphapower.com.au











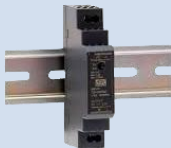

About Alpha Power Systems

Alpha Power Systems is a dedicated designer and manufacturer of sophisticated and rugged power electronics equipment for various markets including telecommunications, utilities, automotive, railway, solar etc.





We offer a wide variety of power conversion products ranging from standalone inverters, N+1 redundancy inverters, UPS to battery chargers, inverter charger combination systems, solar charge controllers, and many more.

We ensure consistent product quality by selecting only superior quality components and subjecting components to rigorous testing and burn-in testing throughout the production process. All the Alpha Power Systems products are certified by TUV and built in accordance with ISO9001. Alpha Power Systems is dedicated to delivering reliable power solutions to all customers.

Mean Well DIN Rail Power Supplies				
Model	Output	Case	Weight	Dimensions (mm)
MDR-10-5 MDR-10-12 MDR-10-15 MDR-10-24	5V / 2A 12V / 0.84A 15V / 0.67A 24V / 0.42A		0.19Kg	22.5 x 90 x 100
DR-15-5 DR-15-12 DR-15-15 DR-15-24	5V / 2.4A 12V / 1.25A 15V / 1.00A 24V / 0.63A		0.11Kg	25 x 93 x 56
HDR-15-5 HDR-15-12 HDR-15-15 HDR-15-24 HDR-15-48	5V / 2.4A 12V / 1.25A 15V / 1.00A 24V / 0.63A 48V / 0.32A		78g	17.5 x 90 x 54.5 Ultra slim design
MDR-20-5 MDR-20-12 MDR-20-15 MDR-20-24	5V / 3.0A 12V / 1.67A 15V / 1.34A 24V / 1.0A		0.2Kg	22.5 x 90 x 100
DR-30-5 DR-30-12 DR-30-15 DR-30-24	5V / 3.0A 12V / 2.0A 15V / 2.0A 24V / 1.5A		0.29Kg	78 x 93 x 56
HDR-30-5 HDR-30-12 HDR-30-15 HDR-30-24 HDR-30-48	5V / 3.0A 12V / 2.0A 15V / 2.0A 24V / 1.5A 48V / 0.75A		0.12Kg	35 x 90 x 54.5 Ultra slim design
MDR-40-5 MDR-40-12 MDR-40-24 MDR-40-48	5V / 6.00A 12V / 3.33A 24V / 1.7A 48V / 0.83A		0.32Kg	40 x 90 x 100
DR-4505 DR-4512 DR-4515 DR-4524	5V / 5.0A 12V / 3.5A 15V / 2.8A 24V / 2.0A		0.34Kg	78 x 93 x 67
DR-60-5 DR-60-12 DR-60-15 DR-60-24	5V / 6.5A 12V / 4.5A 15V / 4.0A 24V / 2.5A		0.32Kg	78 x 93 x 56
HDR-60-5 HDR-60-12 HDR-60-15 HDR-60-24 HDR-60-48	5V / 6.5A 12V / 4.5A 15V / 4.0A 24V / 2.5A 48V / 1.25A		0.19Kg	52.5 x 90 x 54.5 Ultra slim design
MDR-60-5 MDR-60-12 MDR-60-24 MDR-60-48	5V / 10.0A 12V / 5.0A 24V / 2.5A 48V / 1.25A		0.35Kg	40 x 90 x 100





DR-75-12 DR-75-24 DR-75-48	12V / 6.3A 24V / 3.2A 48V / 1.6A		0.65Kg	55.5 x 125.2 x 100
EDR-75-12 EDR-75-24 EDR-75-48	12V / 6.3A 24V / 3.2A 48V / 1.6A		0.55Kg	32 x 125.2 x 102 Slim design
NDR-75-12 NDR-75-24 NDR-75-48	12V / 6.3A 24V / 3.2A 48V / 1.6A		0.55Kg	32 x 125.2 x 102 Slim design
SDR-75-12 SDR-75-24 SDR-75-48	12V / 6.3A 24V / 3.2A 48V / 1.6A		0.51Kg	32 x 125.2 x 102 High Efficiency
DR-100-12 DR-100-15 DR-100-24	12V / 7.5A 15V / 6.5A 24V / 4.2A		0.37Kg	100 x 93 x 56
MDR-100-12 MDR-100-24 MDR-100-48	12V / 7.5A 15V / 6.5A 48V / 2.0A		0.45Kg	55 x 90 x 100
DR-120-12 DR-120-24 DR-120-48	12V / 10.0A 24V / 5.0A 48V / 2.5A		0.83Kg	65.5 x 125.2 x 100
EDR-120-12 EDR-120-24 EDR-120-48	12V / 10A 24V / 5.0A 48V / 2.5A		0.65Kg	40 x 125.2 x 113.5 Slim design
NDR-120-12 NDR-120-24 NDR-120-48	12V / 10.0A 24V / 5.0A 48V / 2.5A		0.65Kg	40 x 125.2 x 113.5 Slim design
SDR-120-12 SDR-120-24 SDR-120-48	12V / 10.0A 24V / 5.0A 48V / 2.5A		0.67Kg	40 x 125.2 x 113.5 High efficiency
WDR-120-12 WDR-120-24 WDR-120-48	12V / 10.0A 24V / 5.0A 48V / 2.5A		0.7Kg	40 x 125.2 x 113.5 Wide input range
EDR-150-24	24V / 10.0A		0.65Kg	40 x 125.2 x 113.5 Slim design
DRP-240-24 DRP-240-48	24V / 10.0A 48V / 5.0A		1.29Kg	125.5 x 125.2 x 100



NDR-240-24 NDR-240-48	24V / 10.0A 48V / 5.0A		1.08Kg	63 x 125.2 x 113.5 Slim design
SDR-240-24 SDR-240-48	24V / 10.0A 48V / 5.0A		1.03Kg	63 x 125.2 x 113.5 High efficiency (94%)
WDR-240-24 WDR-240-48	24V / 10.0A 48V / 5.0A		1.12Kg	63 x 125.2 x 113.5 Wide input range
DRP-480-24 DRP-480-48	24V / 20.0A 59V / 10.0A		2.5Kg	227 x 125.2 x 100 240V Operation Only
DRP-480S-24 DRP-480S-48	24V / 20.0A 48V / 10.0A		2.8Kg	227 x 125.2 x 100 110/240V Operation
NDR-480-24 NDR-480-48	24V / 20.0A 48V / 10.0A		1.95Kg	85.5 x 125.2 x 128.5 Slim design
SDR-480-24 SDR-480-48	24V / 20.0A 48V / 10.0A		1.5Kg	85.5 x 125.2 x 128.5 High efficiency (94%)
SDR-480P-24 SDR-480P-48	24V / 20.0A 48V / 10.0A		1.5Kg	85.5 x 125.2 x 128.5 High Efficiency (94%)
WDR-480-24 WDR-480-48	24V / 20.0A 48V / 10.0A		1.83Kg	85.5 x 125.2 x 128.5 Wide input range
SDR-960-24 SDR-960-48	24V / 40.0A 48V / 20.0A		2.47Kg	110 x 125.2 x 150mm High efficiency (94%)





415V & 3 Phase Input Din Rail Power Supplies				
Model	Output	Case	Weight	Dimensions
DRH-120-24 DRH-120-48	24V / 5.0A 48V / 2.5A		0.80Kg	65.5 x 125.2 x 100mm 340 – 550V _{AC} 2 phase supply
DRT-240-24 DRT-240-48	24V / 10.0A 48V / 5.0A		1.4Kg	125.5 x 125.2 x 100 3 phase supply
DRT-480-24 DRT-480-48	24V / 10.0A 48V / 5.0A		2.7Kg	227 x 125.2 x 100 3 phase supply
DRT-960-24 DRT-960-48	24V / 40.0A 48V / 20.0A		3.6Kg	276 x 125.2 x 100 3 phase supply
TDR-480-24 TDR-480-48	24V / 20.0A 48V / 10.0A		1.51Kg	85.5 x 125.2 x 128.5 3 phase supply
TDR-960-24 TDR-960-48	24V / 40.0A 48V / 20.0A		2.47Kg	110 x 125.2 x 150 3 phase supply

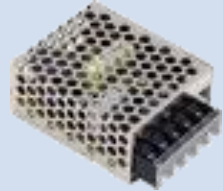
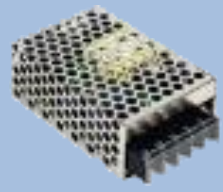

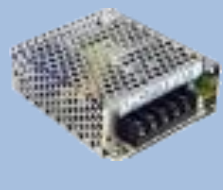

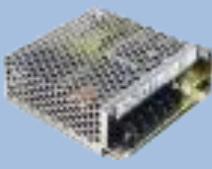
Output Programmable Din Rail Power Supplies				
Model	Output	Case	Weight	Dimensions
DRA-40-12 DRA-40-24	12V / 3.34A 24V / 1.7A		0.3Kg	40 x 90 x 100 Current Programmable
DRA-60-12 DRA-60-24	12V / 5.0A 24V / 2.5A		0.3Kg	40 x 90 x 100 Current Programmable

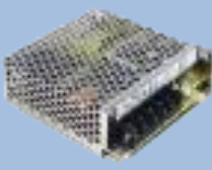
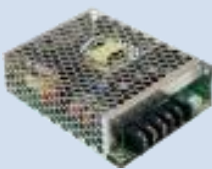



KNX Din Rail Power Supplies				
Model	Output	Case	Weight	Dimensions
KNX-20E-640	30V / 640Ma		0.215Kg	52.5 x 90 x 54.5 KNX Power



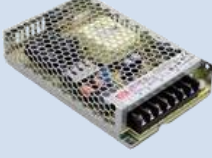
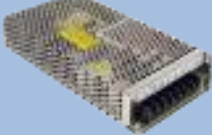

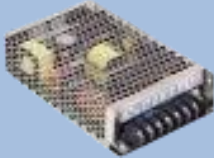
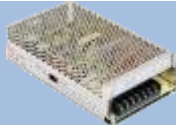

Redundancy & UPS Module Din Rail Power Supplies				
Model	Output	Case	Weight	Dimensions
DR-RDN20	24V / 20.0A		0.5Kg	55.5 x 125.2 x 100 Redundancy module
DR-DRUPS40	24V / 40.0A		0.55Kg	55.5 x 125.2 x 100 UPS module
DRC-40A DRC-40B	13.8V / 2.9A & 13.8V / 1.00A (charger) 27.6V / 1.45A & 27.6V / 0.50A (charger)		0.3Kg	40 x 90 x 100 DC UPS with charger
DRC-60A DRC-60B	13.8V / 4.3A & 13.8V / 1.5A (charger) 27.6V / 2.15A & 27.6V / 0.75A (charger)		0.3Kg	40 x 90 x 100 DC UPS with charger
DRC-100A DRC-100B	13.8V / 4.3A & 13.8V / 2.50A (charger) 27.6V / 3.5A & 27.6V / 1.25A (charger)		0.37Kg	55 x 90 x 100 DC UPS with charger

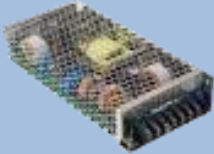





Single Rail Power Supplies				
Model	Output	Case	Weight	Dimensions
RS-15-3.3 RS-15-5 RS-15-12 RS-15-15 RS-26-24 RS-15-48	3.3V / 3.0A 5V / 3.0A 12V / 1.3A 15V / 1.0A 24V / 0.625A 48V / 0.313A		0.14Kg	62.5 x 51 x 28 High temperature 70°C (Mini)
RS-25-3.3 RS-25-5 RS-25-12 RS-25-15 RS-25-24 RS-25-48	3.3V / 6.0A 5V / 5.0A 12V / 2.1A 15V / 1.7A 24V / 1.1A 48V / 0.57A		0.2Kg	78 x 51 x 28 High Temperature 70°C (Mini)
LRS-35-5 LRS-35-12 LRS-35-15 LRS-35-24 LRS-35-36 LRS-35-48	5V / 7.0A 12V / 3.0A 15V / 2.4A 24V / 1.5A 36V / 1.0A 48V / 0.8A		0.23Kg	99 x 82 x 30 Low profile & efficient
RS-35-3.3 RS-35-5 RS-35-12 RS-35-15 RS-35-24 RS-35-48	3.3V / 7.0A 5V / 7.0A 12V / 3.0A 15V / 2.4A 24V / 1.5A 48V / 0.8A		0.3Kg	99 x 82 x 36 High temperature 70°C (Mini)





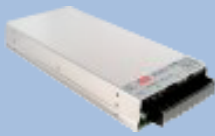

<p>LRS-50-3.3 LRS-50-5 LRS-50-12 LRS-50-15 LRS-50-24 LRS-50-36 LRS-50-48</p>	<p>3.3V / 10.0A 5V / 10.0A 12V / 4.2A 15V / 3.4A 24V / 2.2A 36V / 1.45A 48V / 1.1A</p>		<p>0.23Kg</p>	<p>99 x 82 x 30 Low profile & efficient</p>
<p>RS-50-3.3 RS-50-5 RS-50-12 RS-50-15 RS-50-24 RS-50-48</p>	<p>3.3V / 10.0A 5V / 10.0A 12V / 4.2A 15V / 3.4A 24V / 2.2A 48V / 1.1A</p>		<p>0.41Kg</p>	<p>99 x 97 x 36 High temperature 70°C (Mini)</p>
<p>LRS-75-5 LRS-75-12 LRS-75-15 LRS-75-24 LRS-75-36 LRS-75-48</p>	<p>5V / 14.0A 12V / 6.0A 15V / 5.0A 24V / 3.2A 36V / 2.1A 48V / 1.6A</p>		<p>0.30Kg</p>	<p>99 x 97 x 30 Low profile & efficient</p>
<p>RS-75-3.3 RS-75-5 RS-75-12 RS-75-15 RS-75-24 RS-75-48</p>	<p>3.3V / 15.0A 12V / 6.0A 15V / 5.0A 24V / 3.2A 36V / 2.1A 48V / 1.6A</p>		<p>0.41Kg</p>	<p>129 x 97 x 38 High temperature 70°C (Mini)</p>
<p>HRP-75-3.3 HRP-75-5 HRP-75-7.5 HRP-75-12 HRP-75-15 HRP-75-24 HRP-75-36 HRP-75-48</p>	<p>3.3V / 15.0A 5.0V / 15.0A 7.5V / 10.0A 12V / 6.3A 15V / 5.0A 24V / 3.2A 36V / 2.1A 48V / 1.6A</p>		<p>0.47Kg</p>	<p>129 x 98 x 38 High reliability & 5 year warranty</p>
<p>SP-75-12 SP-75-15 SP-75-24 SP-75-27 SP-75-48</p>	<p>12V / 6.3A 15V / 5.0A 24V / 3.2A 27V / 2.8A 48V / 1.6A</p>		<p>0.60Kg</p>	<p>179 x 97 x 33</p>
<p>RSP-75-3.3 RSP-75-5 RSP-75-7.5 RSP-75-12 RSP-75-13.5 RSP-75-15 RSP-75-24 RSP-75-27 RSP-75-48</p>	<p>3.3V / 15.0A 5V / 15.0A 7.5V / 10.0A 12V / 6.3A 13.5 / 5.6A 15V / 5.0A 24V / 3.2A 27V / 2.8A 48V / 1.6A</p>		<p>0.50Kg</p>	<p>159 x 97 x 30 Ultra low profile</p>









LRS-100-3.3 LRS-100-5 LRS-100-12 LRS-100-15 LRS-100-24 LRS-100-36 LRS-100-48	3.3V / 20.0A 5V / 18.0A 12V / 8.5A 15V / 7.0A 24V / 4.5A 36V / 2.8A 48V / 2.3A		0.34Kg	129 x 97 x 30 Low profile & efficient
RS-100-3.3 RS-100-5 RS-100-12 RS-100-15 RS-100-24 RS-100-48	3.3V / 20.0A 5V / 16.0A 12V / 8.5A 15V / 7.0A 24V / 4.5A 48V / 2.3A		0.6Kg	159 x 97 x 38 High temperature 70°C (Mini)
HRP-100-3.3 HRP-100-5 HRP-100-7.5 HRP-100-12 HRP-100-15 HRP-100-24 HRP-100-36 HRP-100-48	3.3V / 20.0A 5V / 17.0A 7.5V / 13.5A 12V / 8.5A 15V / 7.0A 24V / 4.5A 36V / 2.9A 48V / 2.2A		0.38Kg	159 x 97 x 38 High reliability
RSP-100-3.3 RSP-100-5 RSP-100-7.5 RSP-100-12 RSP-100-13.5 RSP-100-15 RSP-100-24 RSP-100-27 RSP-100-48	3.3V / 20.0A 5V / 20.0A 7.5V / 13.5A 12V / 8.5A 13.5V / 7.5A 15V / 6.7A 24V / 4.2A 27V / 3.8A 48V / 2.1A		0.52Kg	179 x 99 x 30 Ultra low profile
SP-100-12 SP-100-13.5 SP-100-24	12V / 8.5A 13.5V / 7.5A 24V / 4.2A		0.72Kg	179 x 99 x 45
LRS-150-12 LRS-150-15 LRS-150-24 LRS-150-36 LRS-150-48	12V / 12.5A 15V / 10.0A 24V / 6.5A 36V / 4.3A 48V / 3.3A		0.48Kg	159 x 97 x 30 Low profile & efficient
RS-150-3.3 RS-150-5 RS-150-12 RS-150-15 RS-150-24 RS-150-48	3.3V / 30.0A 5V / 26.0A 12V / 12.5A 15V / 10.0A 24V / 6.5A 48V / 3.3A		0.7Kg	High temperature 70°C (Mini)



<p>HRP-150-3.3 HRP-150-5 HRP-150-7.5 HRP-150-12 HRP-150-15 HRP-150-24 HRP-150-36 HRP-150-48</p>	<p>3.3V / 30A 5V / 26A 7.5V / 20A 12V / 13A 15V 10A 24V / 6.5A 36V / 4.3A 48V / 3.3A</p>		<p>0.63Kg</p>	<p>159 x 97 x 38 High reliability & 5 year warranty G : 5Vsb & no load <0.5W</p>
<p>HRPG-150-12 HRPG-150-24</p>	<p>12V / 13A 24V / 6.5A</p>			
<p>S-150-24</p>	<p>24V / 6.5A</p>		<p>0.87Kg</p>	<p>199 x 110 x 50</p>
<p>RSP-150-3.3 RSP-150-5 RSP-150-7.5 RSP-150-12 RSP-150-13.5 RSP-150-15 RSP-150-24 RSP-150-27 RSP-150-48</p>	<p>3.3V / 30.0A 5V / 30.0A 7.5V / 20.0A 12V / 12.5A 13.5V / 11.2A 15V / 10.0A 24V / 6.3A 27V / 5.6A 48V / 3.2A</p>		<p>0.6Kg</p>	<p>199 x 99 x 30 Ultra low profile</p>
<p>SPV-150-12 SPV-150-24 SPV-150-48</p>	<p>12V / 12.5A 24V / 6.25A 48V / 3.125A</p>		<p>1.1Kg</p>	<p>215 x 115 x 50</p>
<p>SP-150-3.3 SP-150-5 SP-150-7.5 SP-150-12 SP-150-13.5 SP-150-15 SP-150-24 SP-150-27 SP-150-48</p>	<p>3.3V / 30.0A 5V / 30.0A 7.5V / 20.0A 12V / 12.5A 13.5V / 11.2A 15V / 10.0A 24V / 8.4A 36V / 5.7A 48V / 3.2A</p>		<p>0.82Kg</p>	<p>199 x 99 x 50</p>
<p>HRP-200-3.3 HRP-200-5 HRP-200-7.5 HRP-200-12 HRP-200-15 HRP-200-24 HRP-200-36 HRP-200-48</p>	<p>3.3V / 40A 5V / 35A 7.5V / 26.7A 12V / 16.7A 15V / 13.4A 24V / 8.4A 36V / 5.7A 48V / 4.3A</p>		<p>0.8Kg</p>	<p>199 x 98 x 38 High reliability & 5 year warranty G : 5Vsb & no load < 0.5W</p>
<p>HRPG-200-12 HRPG-200-24 HRPG-200-36</p>	<p>12V / 16.7A 24V / 8.4A 36V / 5.7A</p>			











<p>RSP-200-2.5 RSP-200-3.3 RSP-200-4 RSP-200-5 RSP-200-7.5 RSP-200-12 RSP-200-13.5 RSP-200-15 RSP-200-24 RSP-200-27 RSP-200-36 RSP-200-48</p>	<p>2.5V / 40.0A 3.3V / 40.0A 4V / 40.0A 5V / 40.0A 7.5 / 26.7A 12V / 16.7A 13.5V / 14.9A 15V / 13.4A 24V / 8.4A 27V / 7.5A 36V / 5.56A 48V / 4.2A</p>		<p>0.72Kg</p>	<p>215 x 115 x 30 Ultra low profile</p>
<p>SP-200-3.3 SP-200-5 SP-200-7.5 SP-200-12 SP-200-13.5 SP-200-15 SP-200-24 SP-200-27 SP-200-48</p>	<p>3.3V / 40.0A 5V / 40.0A 7.5V / 26.7A 12V / 16.7A 13.5V / 14.9A 15V / 13.4A 24V / 8.4A 27V / 7.5A 48V / 4.2A</p>		<p>0.90Kg</p>	<p>199 x 99 x 50</p>
<p>SP-240-5 SP-240-7.5 SP-240-12 SP-240-15 SP-240-24 SP-240-30 SP-240-48</p>	<p>5V / 45.0A 7.5V / 32.0A 12V / 20.0A 15V / 16.0A 24V / 10.0A 30V / 8.0A 48V / 5.0A</p>		<p>0.85Kg</p>	<p>190 x 93 x 50</p>
<p>MSP-300-3.3 MSP-300-5 MSP-300-7.5 MSP-300-12 MSP-300-15 MSP-300-24 MSP-300-36 MSP-300-48</p>	<p>3.3V / 60A 5V / 60A 7.5V / 40A 12V / 27A 15V / 22A 24V / 14A 36V / 9A 48V / 7A</p>		<p>0.95Kg</p>	<p>199 x 105 x 41 Medical, high reliability & 5 year warranty</p>
<p>HRP-300-3.3 HRP-300-5 HRP-300-7.5 HRP-300-12 HRP-300-15 HRP-300-24 HRP-300-36 HRP-300-48</p>	<p>3.3V / 60A 5V / 60A 7.5V / 40A 12V / 27A 15V / 22A 24V / 14A 36V / 9A 48V / 7A</p>		<p>0.95Kg</p>	<p>199 x 105 x 41 High reliability & 5 year warranty G : 5Vsb & No load < 0.5W</p>
<p>HRPG-300-12 HRPG-300-15 HRPG-300-24</p>	<p>12V / 27A 15V / 22A 24V / 14A</p>			
<p>SPV-300-12 SPV-300-24 SPV-300-48</p>	<p>12V / 25A 24V / 12.5A 48V / 6.25A</p>		<p>1.1Kg</p>	<p>215 x 115 x 50 Adjustable output voltage 20 – 110%</p>



RSP-320-2.5 RSP-320-3.3 RSP-320-4 RSP-320-5 RSP-320-7.5 RSP-320-12 RSP-320-13.5 RSP-320-15 RSP-320-24 RSP-320-27 RSP-320-36 RSP-320-48	2.5V / 60A 3.3V / 60A 4V / 60A 5V / 60A 7.5V / 40A 12V / 26.7A 13.5V / 23.8A 15V / 21.4A 24V / 13.4A 27V / 11.9A 36V / 8.9A 48V / 6.7A		0.9Kg	215 x 115 x 30 1 RU low profile
SP-320-3.3 SP-320-5 SP-320-5CC SP-320-7.5 SP-320-12 SP-320-13.5 SP-320-15 SP-320-24 SP-320-27 SP-320-36 SP-320-48	3.3V / 60A 5V / 55A 5V / 55A 7.5V / 40A 12V / 25A 13.5V / 22A 15V / 20A 24V / 13A 27V / 11.7A 36V / 8.8A 48V / 6.7A		1.17Kg	215 x 115 x 50
USP-350-3.3 USP-350-5 USP-350-12 USP-350-15 USP-350-24 USP-350-48	3.3V / 70A 5V / 70A 12V / 29.2A 15V / 23.4A 24V / 14.6A 48V / 7.3A		1.1Kg	235.2 x 101.5 x 38 U frame
HRP-450-3.3 HRP-450-5 HRP-450-7.5 HRP-450-12 HRP-450-15 HRP-450-24 HRP-450-36 HRP-450-48	3.3V / 90A 5V / 90A 7.5V / 60A 12V / 37.5A 15V / 30A 24V / 18.8A 36V / 12.5A 48V / 9.5A		1.19Kg	218 x 105 x 41 High reliability & 5 year warranty G : 5Vsb & No load < 0.5W
HRPG-450-12 HRPG-450-24	12V / 37.5A 24V / 18.8A			
SP-480-3.3 SP-480-5 SP-480-12 SP-480-15 SP-480-24 SP-480-48	3.3V / 85A 5V / 85A 12V / 43A 15V / 35A 24V / 22A 48V / 11A		1.89Kg	278 x 127 x 43
SP-500-12 SP-500-3.5 SP-500-15 SP-500-24 SP-500-27 SP-500-48	12V / 40A 13.5V / 36A 15V / 32A 24V / 20A 27V / 18A 48V / 10A		1.94Kg	170 x 120 x 93

RSP-500-3.3 RSP-500-4 RSP-500-5 RSP-500-12 RSP-500-15 RSP-500-24 RSP-500-27 RSP-500-48	3.3V / 90A 4V / 90A 5V / 90A 12V / 41.7A 15V / 33.4A 24V / 21A 27V / 18.6A 48V / 10.5A		1.3Kg	230 x 127 x 40.5 1RU – low profile
MSP-600-12 MSP-600-24	12V / 53A 24V / 27A		1.57Kg	218 x 105 x 63.5 Medical, high reliability
HRP-600-3.3 HRP-600-5 HRP-600-7.5 HRP-600-12 HRP-600-15 HRP-600-24 HRP-600-36 HRP-600-48	3.3V / 120A 5V / 120A 7.5V / 80A 12V / 53A 15V / 43A 24V / 36A 36V / 17.5A 48V / 13A		1.58Kg	218 x 105 x 63.5 High reliability & 5 year warranty G : 5Vsb & no load <0.75W
HRPG-600-5 HRPG-600-24 HRPG-600-36 HRPG-600-48	5V / 120A 24V / 27A 36V / 17.5A 48V / 13A			
HEP-600-12 HEP-600-15 HEP-600-20 HEP-600-24 HEP-600-30 HEP-600-36 HEP-600-42 HEP-600-48 HEP-600-54	12V / 40A 15V / 36A 20V / 28A 24V / 25A 30V / 20A 36V / 16.7A 42V / 14.3A 48V / 12.5A 54V / 11.2A		3.9Kg	280 x 144 x 48.5 Harsh environment, fanless
PSP-600-5 PSP-600-12 PSP-600-13.5 PSP-600-15 PSP-600-24 PSP-600-27 PSP-600-48	5V / 80A 12V / 50A 13.5V / 44.5A 15V / 40A 24V / 25A 27V / 22.2A 48V / 12.5A		1.9Kg	170 x 120 x 93
RSP-750-5 RSP-750-12 RSP-750-15 RSP-750-24 RSP-750-27 RSP-750-48	5V / 100A 12V / 62.5A 15V / 50A 24V / 31.3A 27V / 27.8A 48V / 15.7A		1.64Kg	250 x 127 x 41 1RU low profile
SP-750-5 SP-750-12 SP-750-15 SP-750-24 SP-750-27 SP-750-48	5V / 120A 12V / 62.5A 15V / 50A 24V / 31.3A 27V / 27.8A 48V / 15.7A		3.1Kg	278 x 127 x 63.5





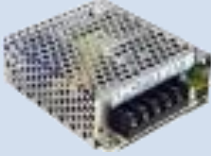
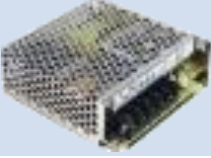
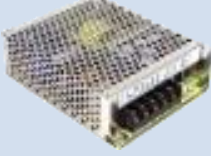

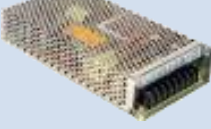
RSP-1000-12 RSP-1000-15 RSP-1000-24 RSP-1000-27 RSP-1000-48	12V / 60A 15V / 50A 24V / 40A 27V / 37A 48V / 21A		1.95Kg	295 x 127 x 41 1RU low profile
RSP-1500-5 RSP-1500-12 RSP-1500-15 RSP-1500-24 RSP-1500-27 RSP-1500-48	5V / 240A 12V / 125A 15V / 100A 24V / 63A 27V / 37A 48V / 32A		3Kg	278 x 127 x 83.5
SPV-1500-12 SPV-1500-24 SPV-1500-48	12V / 125A 24V / 63A 48V / 32A		3.15Kg	278 x 127 x 83.5 Adjustable output voltage 20 – 110%
RSP-1600-12 RSP-1600-24 RSP-1600-27 RSP-1600-36 RSP-1600-48	12V / 125A 24V / 67A 27V / 56A 36V / 44.5A 48V / 32A		1.8Kg	300 x 85 x 41 1RU low profile
RSP-2000-12 RSP-2000-24 RSP-2000-48	12V / 100A 24V / 80A 48V / 42A		1.95Kg	295 x 127 x 41
RSP-2400-12 RSP-2400-24 RSP-2400-48	12V / 166.7A 24V / 100A 48V / 50A		3.3Kg	278 x 177.8 x 63.5
RSP-3000-12 RSP-3000-24 RSP-3000-48	12V / 200A 24V / 125A 48V / 62.5A		4Kg	278 x 177.8 x 63.5
RST-5000-24 RST-5000-36 RST-5000-48	24V / 200A 36V / 138A 48V / 105A		10Kg	460 x 211 x 83.5 3 phase input
RST-10000-24 RST-10000-36 RST-10000-48	24V / 400A 36V / 276A 48V / 210A		23.5Kg	540 x 424 x 83.5 3 phase input

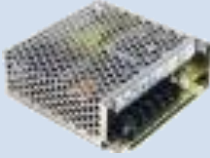
19" Rack Power Supplies				
Model	Output	Case	Weight	Dimensions
RCP-1000-12 RCP-1000-24 RCP-1000-48	12V / 60A 24V / 40A 48V / 21A		1.91Kg	295 x 127 x 41
RCP-1U	1RU cassette for RCP-1000		-	350.8 x 483.6 x 44 I : AC inlet T : Terminal block

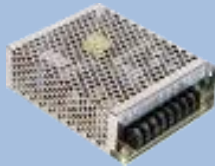
RCP-1000C-12 RCP-1000C-24 RCP-1000C-48	12V / 60A 24V / 40A 48V / 21A		1.91Kg	295 x 127 x 41
RCP-MU	RCP-1000C monitor & controller		-	440 x 68 x 44
RCP-1U	1RU Cassette for RCP-1000C		-	350.8 x 483.6 x 44 I : AC inlet T : Terminal Block
RCP-1600-12 RCP-1600-24 RCP-1600-48	12V / 125A 24V / 67A 48V / 33.5A		1.87Kg	300 x 85 x 41
RHP-1U	1RU cassette for RCP-1600		-	440 x 365 x 44 I : AC inlet T : Terminal block
RCB-1600-12 RCB-1600-24 RCB-1600-48	14.4V / 100A 28.8V / 55A 57.6V / 27.5A		1.87Kg	300 x 85 x 41 Battery charger
RHP-1U	1RU cassette for RCB-1600		-	440 x 365 x 44 I : AC inlet T : Terminal block
RCP-2000-12 RCP-2000-24 RCP-2000-48	12V / 100A 24V / 80A 48V / 42A		1.95Kg	295 x 127 x 41
RKP-1U	1RU cassette for RCP-2000		-	350.8 x 483.6 x 44 I : AC inlet T : Terminal Block
RKP-CMU1	RCP-2000 monitor & controller		-	147.5 x 127 x 41
RKP-1U-CMU1	RCP-2000 monitor & controller with 1 RU cassette		-	350.8 x 483.6 x 44

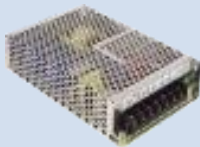

Dual Rail Power Supplies				
Model	Output	Case	Weight	Dimensions
RD-35A	5V / 0.3 – 4A 12V / 0.2 – 1A		0.3Kg	99 x 82 x 36 High temperature 70°C
RD-35B	5V / 0. – 4A 24V / 0.2 – 1.3A			
RD-50A	5V / 0.3 – 6A 12V / 0.3 – 3A		0.41Kg	99 x 97 x 36 High temperature 70°C
RD-50B	5V / 0.3 – 6A 24V / 0.2 – 4A			
RD-65A	5V / 0.3 – 8A 12V / 0.2 – 4A		0.44Kg	129 x 98 x 38 High temperature 70°C
RD-65B	5V / 0.3 – 8A 24V / 0.2 – 3A			
RD-85A	5V / 2 – 10A 12V / 0.3 – 5A		0.6Kg	159 x 97 x 38 High temperature 70°C
RD-85B	5V / 2 – 10A 24V / 0.3 – 2.5A			
RD-125A	5V / 2 – 15A 12V / 0.5 – 10A		0.7Kg	199 x 98 x 38 High temperature 70°C
RD-125B	5V / 2 – 10A 24V / 0.4 – 5A			
RID-125-1250	5V / 2 – 10.5A 12V / 0 – 3A		0.7Kg	High temperature 70°C
RID-125-1224	12V / 1 – 7A 24V / 0.4 – 5A			



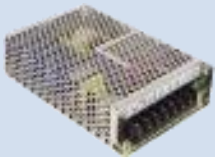
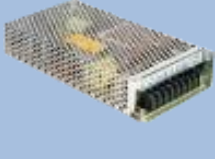

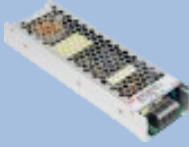

Triple Rail Power Supplies				
Model	Output	Case	Weight	Dimensions
RT-50A	5V / 0.5 – 5A 12V / 0.2 – 2.5A -5V / 0.1 – 1A		0.41Kg	99 x 97 x 36 High temperature 70°C
RT-50B	5V / 0.5 – 5A 12V / 0.2 – 2.5A -12V / 0.1 – 1A			
RT-50C	5V / 0 – 5A 15V / 0.2 – 2A -15V / 0.1 – 1A			
RT-50D	5V / 0.5 – 5A 24V / 0.2 – 1.5A 12V / 0.1 – 1A			

RT-65A	5V / 0.5 – 8A 12V / 0.2 – 3.5A -5V / 0 – 1A		0.44Kg	129 x 98 x 38 High temperature 70°C
RT-65B	5V / 0.5 – 8A 12V / 0.2 – 3.5A -12V / 0 – 1A			
RT-65C	5V / 0.5 – 8A 15V / 0.2 – 3A -15V / 0 – 1A			
RT-65D	5V / 0.5 – 8A 24V / 0.2 – 2A 12V / 0.1 – 1A			
TP-75B	5V / 1.5 – 10A 12V / 0.2 – 4A -12V / 0 – 0.6A		0.65Kg	179 x 99 x 33
RT-85A	5V / 2 – 10A 12V / 0.3 – 4A -5V / 0 – 1A		0.6Kg	159 x 97 x 38 High temperature 70°C
RT-85B	5V / 2 – 10A 12V / 0.3 – 4A -12V / 0 – 1A			
RT-85C	5V / 2 – 10A 15V / 0.3 – 4A -15V / 0 – 1A			
RT-85D	5V / 2 – 10A 24V / 0.3 – 2.5A 12V / 0.1 – 1A			
TP-100A	5V / 3 – 15A 12V / 0.4 – 5A -5V / 0 – 1A		0.83Kg	199 x 99 x 50
RT-125A	5V / 2 – 15A 12V / 0.5 – 6A -5V / 0 – 1A		0.7Kg	199 x 98 x 38 High temperature
RT-125B	5V / 2 – 15A 12V / 0.5 – 6A -12V / 0.1 – 1A			
RT-125C	5V / 2 – 15A 15V / 0.5 – 6A -15V / 0.1 – 1A			
RT-125D	5V / 2 – 15A 24V / 0.4 – 4A 12V / 0.1 – 2A			
TP-150A	5V / 2 – 20A 12V / 0.4 – 7A -5V / 0 – 1A		0.9Kg	199 x 99 x 50
TP-150B	5V / 2 – 20A 12V / 0.4 – 7A -12V / 0 – 1A			
TP-150C	5V / 2 – 20A 15V / 0.4 – 6A -15V / 0 – 1A			





Quad Rail Power Supplies				
Model	Output	Case	Weight	Dimensions
RQ-50B	5V / 0.5 – 6A 12V / 0.2 – 1.5A -5V / 0 – 1A -12V / 0 – 1A		0.41Kg	99 x 97 x 36 High temperature 70°C
RQ-50C	5V / 0.5 – 6A 15V / 0.2 – 1.5A -5V / 0 – 1A -15V / 0 – 1A			
RQ-50D	5V / 0.5 – 6A 12V / 0.2 – 1.5A 24V / 0.1 – 1A -12V / 0 – 1A			
RQ-65B	5V / 0.5 – 8A 12V / 0.2 – 3A -5V / 0 – 1A -12V / 0 – 1A		0.44Kg	129 x 98 x 38 High temperature 70°C
RQ-65C	5V / 0.5 – 8A 15V / 0.2 – 3A -5V / 0 – 1A -15V / 0 – 1A			
RQ-65D	5V / 0.5 – 8A 12V / 0.2 – 3A 24V / 0.1 – 1.5A -12V / 0 – 1A			
RQ-85B	5V / 2 – 10A 12V / 0.3 – 4A -5V / 0 – 1A -12V / 0 – 1A		0.6Kg	159 x 97 x 38 High temperature 70°C
RQ-85C	5V / 2 – 10A 15V / 0.3 – 4A -5V / 0 – 1A -15V / 0 – 1A			
RQ-85D	5V / 2 – 10A 12V / 0.3 – 4A 24V / 0.1 – 1.5A -12V / 0 – 1A			
RQ-125B	5V / 2 – 12A 12V / 0.5 – 4.5A -5V / 0.1 – 1A -12V / 0 – 1A		0.7Kg	199 x 98 x 38 High temperature 70°C
RQ-125C	5V / 2 – 12A 15V / 0.5 – 4A -5V / 0.1 – 1A -15V / 0 – 1A			
RQ-125D	5V / 2 – 12A 12V / 0.5 – 4A 24V / 0.1 – 2.5A -12V / 0 – 1A			

QP-150B	5V / 3 – 15A 12V / 0.4 – 5A -12V / 0.3 – 2A -5V / 0 – 1A		1.1Kg	199 x 99 x 50
QP-150C	5V / 3 – 15A 15V / 0.4 – 4A -15V / 0.3 – 2A -5V / 0 – 1A			
QP-150D	5V / 3 – 15A 12V / 0 – 5A 24V / 0.4 – 3A -12V / 0 – 1A			
QP-150F	5V / 3 – 15A 15V / 0 – 5A 24V / 0.4 – 3A -15V / 0 – 1A			
QP-200D	5V / 3 – 20A 12V / 0 – 7A 24V / 0.4 – 6A -12V / 0 – 1A		1.2Kg	215 x 115 x 50
QP-200F	5V / 3 – 20A 15V / 0 – 6A 24V / 0.4 – 6A -15V / 0 – 1A			
QP-320D	5V / 2.5 – 20A 12V / 0 – 10A 24V / 0.2 – 5A -12V / 0.2 – 2A		1.2Kg	215 x 115 x 50
QP-320F	5V / 2.5 – 20A 15V / 0 – 10A 24V / 0.2 – 5A -15V / 0.2 – 1.6A			











LED Sign Power Supplies				
Model	Output	Case	Weight	Dimensions
HSP-150-2.5 HSP-150-3.8 HSP-150-5	2.5V / 30A 3.8V / 30A 5V / 30A		0.61Kg	220 x 62 x 32 Low profile
HSP-200-4.2 HSP-200-5	4.2V / 40A 5V / 40A		0.61Kg	210 x 62 x 31 Low profile
HSP-300-2.8 HSP-300-4.2 HSP-300-5	2.8V / 60A 4.2V / 60A 5V / 60A		0.8Kg	210 x 81 x 31 Low profile













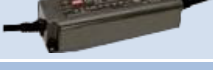

Constant Current LED Driver				
Model	Output	Case	Weight	Dimensions
PLM-12E-350 PLM-12E-500 PLM-12E-700 PLM-12E-1050	22 – 36V / 350mA 15 – 24V / 500mA 11 – 18V / 700mA 7 – 12V / 1050mA		0.126Kg	145 x 38 x 22 180 – 295V _{AC} input
PCD-16-350B PCD-16-700B	24 / 48V / 350mA 16 – 24V / 700mA		0.3Kg	84 x 57 x 29.5 Trailing edge dimming
PCD-16-1050B PCD-16-1400B	12 – 16V / 1050mA 8 – 12V / 1400mA			
LCM-25	6 – 54V 350mA 6 – 50V / 500mA 6 – 42V / 600mA 6 – 36V / 700mA 6 – 28V / 900mA 6 – 24V / 1050mA		0.16Kg	105 x 68 x 23
LCM-25DA	6 – 54V / 350mA 6 – 50V / 500mA 6 – 42V / 600mA 6 – 36V / 700mA 6 – 28V / 900mA 6 – 24V / 1050mA		0.17Kg	105 x 68 x 23 Built-in DALI interface
PCD-25-350B	40 – 58V / 350mA		0.35Kg	84 x 57 x 29.5 Trailing edge dimming
PCD-25-1050B	24 – 36V / 700mA			
PCD-25-1050B	16 – 24V / 1050mA			
PCD-25-1400B	12 – 18V / 1400mA			
PLM-25E-350 PLM-25E-500 PLM-25E-700 PLM-25E-1050	42 – 72V / 350mA 30 – 50V / 500mA 21 – 36V / 700mA 14 – 24V / 1050mA		0.125Kg	145 x 38 x 22 180 – 295V _{AC} input
LCM-40	2 – 100V / 350mA 2 – 80V / 500mA 2 – 67V / 600mA 2 – 57V / 700mA 2 – 45V / 900mA 2 – 40V / 1050mA		0.24Kg	123.5 x 81.5 x 23
LCM-40DA-AUX	2 – 100V / 350mA 2 – 80V / 500mA 2 – 67V / 600mA 2 – 57V / 700mA 45V / 900mA 2 – 40V / 1050mA		0.24Kg	123.5 x 81.5 x 23 Built-in DALI interface
PCD-40 Series	-		-	128 x 60 x 31.5











PLM-40E-350 PLM-40E-500 PLM-40E-700 PLM-40E-1050 PLM-40E-1400 PLM-40E-1750	53 – 105V / 350mA 40 – 80V / 500mA 29 – 57V / 700mA 19 – 38V / 1050mA 15 – 29V / 1400mA 12 – 23V / 1750mA		0.175Kg	175 x 42 x 24 180 – 295V _{AC} input
LCM-60	2 – 90V / 500mA 2 – 90V / 600mA 2 – 86V / 700mA 2 – 67V / 900mA 2 – 57V / 1050mA 2 – 42V / 1400mA		0.24Kg	123.5 x 81.5 x 23
LCM-60DA-AUX	2 – 90V / 500mA 2 – 90V / 600mA 2 – 86V / 700mA 2 – 67V / 900mA 2 – 57V / 1050mA 2 – 42V / 1400mA		0.24Kg	123.5 x 81.5 x 23 Built-in DALI interface
PCD-60 Series	-		-	128 x 60 x 31.5 Trailing edge dimming
HVGC-65-350 □ HVGC-65-500 □ HVGC-65-700 □ HVGC-65-1050 □	18 – 186V / 350mA 13 – 130V / 500mA 9 – 93V / 700mA 6 – 62V / 1050mA		0.77Kg	189 x 61.5 x 36.8 □: suffix: A: IP65 adjustable B: IP67 dimming
ELG-75-C350 □ ELG-75-C500 □ ELG-75-C700 □ ELG-75-C1050 □ ELG-75-C1400 □	107 – 214V / 350mA 75 – 150V / 500mA 53 – 107V / 700mA 35 – 71V / 1050mA 27 – 54V / 1400mA		0.7Kg	180 x 63 x 35.5 □: suffix: A: IP65 adjustable B: IP67 dimming
HVGC-100-350 □ HVGC-100-700 □	29 – 285V / 350mA 15 – 142V / 700mA		1.18Kg	236 x 68 x 38.8 □: suffix: A: IP65 adjustable B: IP67 dimming
ELG-100-C350 □ ELG-100-C500 □ ELG-100-C700 □ ELG-100-C1050 □ ELG-100-C1400 □	143 – 286V / 350mA 100 – 200V / 500mA 71 – 143V / 700mA 48 – 95V / 1050mA 35 – 72V / 1400mA		0.75Kg	199 x 63 x 35.5 □: suffix: A: IP65 adjustable B: IP67 dimming:
HVGC-150-350 □ HVGC-150-500 □ HVGC-150-700 □ HVGC-150-1050 □ HVGC-150-1400 □	42 – 428V / 350mA 30 – 300V / 500mA 21 – 215V / 700mA 15 – 143V / 1050mA 12 – 107V / 1400mA		1.24Kg	245 x 68 x 38.8 □: suffix: A: IP65 adjustable B: IP67 dimming
ELG-150-C500 □ ELG-150-C700 □ ELG-150-C1050 □ ELG-150-C1400 □ ELG-150-C1750 □ ELG-150-C2100 □	150 – 300V / 500mA 107 – 214V / 700mA 72 – 143V / 1050mA 54 – 107V / 1400mA 43 – 86V / 1750mA 36 – 72V / 2100mA		0.85Kg	219 x 63 x 35.5 □: suffix: A: IP65 adjustable B: IP67 dimming







HLG-185H-C700B	143 – 286V / 700mA		1.15Kg	228 x 68 x 38.8 IP67 dimming
HLG-240H-C2100A HLG-240H/C2100B	59 – 119V / 2100mA		1.3Kg	244.2 x 68 x 38.8 A: IP65 adjustable B: IP67 dimming
HVGC-240-700 □ HVGC-240-1050 □ HVGC-240-1400 □ HVGC-240-1750 □ HVGC-240-2100 □ HVGC-240-2800 □ HVGC-240-3500 □	171.4 – 342.8V / 700mA 114.3 – 228.6V / 1050mA 85.7 – 171.4V / 1400mA 68.5 – 137.1V / 1750mA 57.2 – 114.3V / 2100mA 42.9 – 85.7V / 2800mA 34.36 – 68.6V / 3500mA		1.35Kg	254.2 x 68 x 38.8 □: suffix: A: IP65 adjustable B: IP67 dimming
HVGC-320-700 □ HVGC-320-1050 □ HVGC-320-1400 □ HVGC-320-1750 □ HVGC-320-2100 □ HVGC-320-2800 □ HVGC-320-3500 □	214 – 428V / 700mA 152.4 – 304.8V / 1050mA 114.3 – 228.6V / 1400mA 114.3 – 228.6V / 1750mA 91.1 – 182.8V / 2100mA 57 – 114.3V / 2800mA 45.7 – 91.4V / 3500mA		2.0Kg	595 x 90 x 43.8 □: suffix: A: IP65 adjustable B: IP67 dimming



Constant Voltage LED Drivers

Model	Output	Case	Weight	Dimensions
APV-12-12 APV-12-24	12V / 1A 24V / 0.5A		0.25Kg	77 x 40 x 29
APV-16-12 APV-16-24	12V / 1.25A 24V / 0.67A		0.25Kg	77 x 40 x 29
LPF-16D-12 LPF-16D-24	12V / 1.34A 24V / 0.67A		0.45Kg	148 x 40 x 32
PLN-20-12 PLN-20-24	12V / 1.6A 24V / 0.8A		0.40Kg	148.5 x 38.5 x 28
LPF-25D-12 LPF-25D-24	12V / 2.1A 24V / 1.05A		0.55Kg	148 x 40 x 32
PLN-30-12 PLN-30-24	12V / 2.5A 24V / 1.25A		0.40Kg	145 x 47 x 30
HLG-40H-12 □ HLG-40H-24 □	12V / 3.33A 24V / 1.67A		0.9Kg	171 x 61.5 x 36.8 □: suffix: A: IP65 adjustable B: IP67 dimming
LPF-40D-12 LPF-40D-24 LPF-40D-6	12V / 3.34A 24V / 1.67A 36V / 1.12A		0.60Kg	162.5 x 43 x 32
PWM-40-12 PWM-40-24	12V / 3.34A 24V / 1.67A		-	150 x 53 x 35 PWM LED strip, dimming
CLG-60-12 CLG-60-24	12V / 5A 24V / 2.5A		1Kg	195.6 x 61.5 x 38.8

LPF-60-12 LPF-60-24	12V / 5A 24V 2.5A		0.6Kg	162.5 x 43 x 32
HLG-60H-24 □ HLG-60H-30B HLG-60H-36 HLG-60H-59 □ HLG-60H-54 □	24V / 2.5A 30V / 2A 36V / 1.7A 48V / 1.3A 54V / 1.15A		0.9Kg	171 x 61.5 x 36.8 □: suffix: A: IP65 adjustable B: IP67 dimming Otherwise: IP67
LPF-60D-12 LPF60D-24 LPF-60D-36	12V / 5A 24V / 2.5A 36V / 1.67A		0.6Kg	162.5 x 43 x 32
PLN-60-12 PLN-60-24	12V / 5A 24V / 2.5A		0.65Kg	181 x 61.5 x 35
PWM-60-12 PWM-60-24	12V / 5A 24V / 2.5A		-	150 x 53 x 35 PWM LED strip, dimming
ELG-75-12 □ ELG-75-24 □ ELG-75-36 □ ELG-75-42 □ ELG-75-48 □	12V / 5A 24V / 3.15A 36V / 2.1A 42V / 1.8A 48V / 1.6A		1Kg	180 x 63 x 35.5 □: suffix: A: IP65 adjustable B: IP67 dimming Otherwise: IP67
ELG-75-12DA ELG-75-24DA ELG-75-36DA ELG-75-42DA ELG-75-48DA	12V / 5A 24V / 3.15A 36V / 2.1A 42V / 1.8A 48V / 1.6A		1Kg	180 x 63 x 35.5 DA: DALI control tech
HLG-80G-12 □ HLG-80H-24 □	12V / 5A 24V / 3.4A		1.05Kg	195.6 x 61.5 x 38.8 □: suffix: A: IP65 adjustable B: IP67 dimming Otherwise: IP67
LPF-90F-24 LPF-90F-36	24V / 3.75A 36V / 2.5A		0.85Kg	161 x 61 x 36
PWM-90-12 PWM-90-24	12V / 7.5A 24V / 3.75A		-	171 x 63 x 37.5 PWM LED strip, dimming
CLG-100-24	24V / 4A		1.25Kg	222.2 x 68 x 38.8
PLN-100-24	24V / 4A		0.8Kg	200 x 70.5 x 35
ELG-100-24 □ ELG-100-36 □ ELG-100-42 □ ELG-100-48 □ ELG-100-54 □	24V / 4A 36V / 2.66A 42V / 2.28A 48V / 2A 54V / 1.78A		1Kg	199 x 63 x 35.5 □: suffix: A: IP65 adjustable B: IP67 dimming Otherwise: IP67
ELG-100-24DA ELG-100-36DA ELG-100-42DA ELG-100-48DA ELG-100-54DA	24V / 4A 36V / 2.66A 42V / 2.28A 48V / 2A 54V / 1.78A		1Kg	199 x 63 x 35.5 DA: DALI control tech



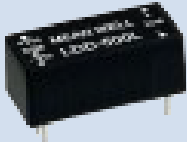

<p>HLG-100H-24□ HLG-100H-30A HLG-100H-36□ HLG-100H-48□</p>	<p>24V / 4A 30V / 3.2A 36V / 2.65A 48V / 2A</p>		<p>1.6Kg</p>	<p>220 x 68 x 38.8 □: suffix: A: IP65 adjustable B: IP67 dimming Otherwise: IP67</p>
<p>HLG-120H-12□ HLG-120H-24□ HLG-120H-30A HLG-120H-48A</p>	<p>12V / 10A 24V / 5A 30V / 4A 48V / 2.5A</p>		<p>1.3Kg</p>	<p>220 x 68 x 38.8 □: suffix: A: IP65 adjustable B: IP67 dimming Otherwise: IP67</p>
<p>PWM-120-12 PWM-120-240</p>	<p>12V / 10A 24V / 5A</p>		<p>-</p>	<p>191 x 63 x 37.5</p>
<p>CLG-150-12 CLG-150-24</p>	<p>12V / 11A 24V / 6.3A</p>		<p>1.25Kg</p>	<p>222.2 x 68 x 38.8</p>
<p>ELG-150-12□ ELG-150-24□ ELG-150-36□ ELG-150-42□ ELG-150-48□ ELG-150-54□</p>	<p>12V / 10A 24V / 6.25A 36V / 4.17A 42V / 3.57A 48V / 3.13A 54V / 2.8A</p>		<p>1.1Kg</p>	<p>219 x 63 x 35.5 DA: DALI control tech</p>
<p>ELG-150-12DA ELG-150-24DA ELG-150-36DA ELG-150-42DA ELG-150-48DA ELG-150-54DA</p>	<p>12V / 10A 24V / 6.25A 36V / 4.17A 42V / 3.57A 48V / 1.13A 54V / 2.8A</p>		<p>1.1Kg</p>	<p>219 x 63 x 35.5 □: suffix: A: IP65 adjustable B: IP67 dimming</p>
<p>HLG-150H-12□ HLG-150H-24□ HLG-150H-48</p>	<p>12V / 12.5A 24V / 6.3A 48V / 3.2A</p>		<p>1.3Kg</p>	<p>228 x 68 x 38.8 □: suffix: A: IP65 adjustable B: IP67 dimming Otherwise: IP67</p>
<p>HLG-185H-12□ HLG-185H-24□ HLG-185H-48A HLG-185H-54B</p>	<p>12V / 13A 24V / 7.8A 48V / 3.9A 54V / 3.45A</p>		<p>1.3Kg</p>	<p>228 x 68 x 38.8</p>
<p>HLG-320H-12□ HLG-320H-24□ HLG-320H-36A HLG-320H-42A HLG-320H-48A HLG-320H-54B</p>	<p>12V / 22A 24V / 13.34A 36V / 8.9A 42V / 7.65A 48V / 6.7A 54V / 5.95A</p>		<p>2.1Kg</p>	<p>252 x 90 x 43.8 □: suffix: A: IP65 adjustable B: IP67 dimming Otherwise: IP67</p>
<p>HLG-600H-12□ HLG-600H-24□ HLG-600H-48B</p>	<p>12V / 40A 24V / 25A 48V / 12.5A</p>		<p>4.5Kg</p>	<p>280 x 144 x 48.5 □: suffix: A: IP65 adjustable B: IP67 dimming</p>





LED Accessories				
Model	Output	Case	Weight	Dimensions
DAP-04	4 Channel Converts DALI to PWM Compatible with 3-in-1 dimming drivers		0.16Kg	165 x 46 x 23
DAP-04-S01	1 CHANNEL Converts DALI to PWM Compatible with 3-in-1 dimming drivers		0.16Kg	165 x 46 x 23
SDF-30	Analogue 1-10V dimming switch used with: HLG-B series, LPF-D series, PWM series, ELG-B series & LCM Series		-	-
SPD-20-240P	Max. surge current: 20kA Response time: < 25ns Operating temp: -40 – +70°C		0.39Kg	90 x 70 x 50
CJ04-1 CJ04-2	1 – 16 AWG 18 – 22 AWG		-	Waterproof cable joiner for LED drivers
PIR-045	Photoelectric motion sensor		-	-
SDP-001	Smart timer dimming programmer Programmer for ELG timer dimming function		-	-



DC-DC LED Drivers				
Model	Output	Case	Weight	Dimensions
LDD-300L LDD-350L LDD-500L LDD-600L LDD-700L	2 – 32V / 300mA 2 – 32V / 350mA 2 – 32V / 500mA 2 – 32V / 600mA 2 – 32V / 700mA		4g	22.6 x 9.9 x 8.9
LDD-1000L LDD-1200L LDD-1500L	2 – 30V / 1000mA 2 – 30V / 1200mA 2 – 30V / 1500mA		7.3g	31.8 x 20.3 x 12.2
LDD-300LW LDD-240LW LDD-500LW LDD-600LW LDD-700LW	2 – 32V / 300mA 2 – 32V / 350mA 2 – 32V / 500mA 2 – 32V / 600mA 2 – 32V / 700mA			7.3g
LDD-1000LW LDD-1200LW LDD-1500LW	2 – 30V / 1000mA 2 – 30V / 1200mA 2 – 30V / 1500mA	7.3g		31.8 x 20.3 x 12.2







LDD-300LS LDD-350LS LDD-500LS LDD-600LS LDD-700LS	2 – 32V / 300mA 2 – 32V / 350mA 2 – 32V / 500mA 2 – 32V / 600mA 2 – 32V / 700mA		3.4g	25.4 x 10.5 x 9.3
LDD-1000LS LDD-1200LS LDD-1500LS	2 – 30V / 1000mA 2 – 30V / 1200mA 2 – 30V / 1500mA		7.3g	31.8 x 20.3 x 10.9
LDD-300H LDD-350H LDD-500H LDD-600H LDD-700H LDD-1000H	2 – 52V / 300mA 2 – 52V / 350mA 2 – 52V / 500mA 2 – 52V / 600mA 2 – 52V / 700mA 2 – 52V / 1000mA		15.6g	31.8 x 20.3 x 12.2
LDD-1200H LDD-1500H	2 – 46V / 1200mA 2 – 46V / 1500mA		18g	31.8 x 20.3 x 12.2
LDD-300HS LDD-350HS LDD-500HS LDD-600HS LDD-700HS LDD-1000HS	2 – 52V / 300mA 2 – 52V / 350mA 2 – 52V / 500mA 2 – 52V / 600mA 2 – 52V / 700mA 2 – 52V / 1000mA		12.8g	31.8 x 20.3 x 11.4
LDB-300L LDB-350L LDB-500L LDB-600L	2 – 40V / 300mA 2 – 40V / 350mA 2 – 32V / 500mA 2 – 30V / 600mA		15.6g	31.8 x 20.3 x 12.2
LDB-300LW LDB-350LW LDB-500LW LDB-600LW	2 – 40V / 300mA 2 – 40V / 350mA 2 – 32V / 500mA 2 – 30V / 600mA		18g	31.8 x 20.3 x 12.2
LDH-45A-350 □ LDH-45A-500 □ LDH-45A-700 □ LDH-45A-1050 □	12 – 86V / 350mA 12 – 86V / 500mA 12 – 64V / 700mA 12 – 43V / 1050mA		138g	75 x 53 x 22.7 □: suffix: Blank: Pin Style W: Wire Style
LDH-45B-350 □ LDH-45B-500 □ LDH-45B-700 □ LDH-45B-1050 □	21 – 126V / 350mA 21 – 86V / 500mA 21 – 64V / 700mA 21 – 43V / 1050mA			





LDH-45A-350WDA	12 – 86V / 350mA		138g	75 x 53 x 22.7 WDA: wire style with DALI dimming
LDH-45A-500WDA	12 – 86V / 500mA			
LDH-45A-700WDA	12 – 64V / 700mA			
LDH-45A-1050WDA	21 – 43V / 1050mA			
LDH-45B-350WDA	21 – 126V / 350mA			
LDH-45B-500WDA	21 – 86V / 500mA			
LDH-45B-700WDA	21 – 64V / 700mA			
LDH-45B-1050WDA	21 – 43V / 1050mA			





Open Frame LED Drivers				
Model	Output	Case	Weight	Dimensions
PLP-20-12 PLP-20-18 PLP-20-24 PLP-20-36 PLP-20-48	12V / 1.6A 18V / 1.1A 24V / 0.8A 36V / 0.55A 48V / 0.42A		0.12Kg	140 x 32 x 22
PLP-30-12 PLP-30-24 PLP-30-48	12V / 2.5A 24V / 1.3A 48V / 0.63A		0.12Kg	101.6 x 50.8 x 26.6
PLP-45-12 PLP-45-24 PLP-45-48	12V / 3.8A 24V / 1.9A 48V / 0.95A		0.16Kg	101.6 x 50.8 x 29.6
PLP-60-12 PLP-60-24 PLP-60-48	12V / 5A 24V / 2.5A 48V / 1.3A		0.16Kg	101.6 x 50.8 x 29.6
PLP-60H-15 PLP-60H-20 PLP-60H-24 PLP-60H-30 PLP-60H-36 PLP-60H-42 PLP-60H-48 PLP-60H-54	15V / 4A 20V / 3A 24V / 2.5A 30V / 2A 36V / 1.7A 42V / 1.45A 48V / 1.3A 54V / 1.15A		0.2Kg	147 x 53 x 27 3-in-1 dimming function





High Bay LED Drivers				
Model	Output	Case	Weight	Dimensions
HBG-60-1050P HBG-60-1400P HBG-60-2100P	37 – 55V / 1050mA 28 – 43V / 1400mA 19 – 29V / 2100mA		0.21Kg	Φ 99 x 26mm PCB type
HBG-60-1050 HBG-60-1400 HBG-60-2100	37 – 55V / 1050mA 28 – 43V / 1400mA 19 – 29V / 2100mA		0.5Kg	Φ 110 x 60.5mm Enclosed type
HBG-100-24□ HBG-100-36□ HBG-100-48□ HBG-100-60□	24V / 4A 36V / 2.7A 48V / 2A 60V / 1.6A		1.1Kg	Φ 130 x 66.5 □: suffix: A: IP65 adjustable B: IP67 dimming Otherwise: IP67
HBG-160-24□ HBG-160-36□ HBG-160-48□ HBG-160-60□	24V / 6.5A 36V / 4.4A 48V / 3.3A 60V / 2.6A		1.52Kg	Φ 151.68 x 66.5 □: suffix: A: IP65 adjustable B: IP67 dimming Otherwise: IP67
HBG-240-24□ HBG-240-36□ HBG-240-48□ HBG-240-60□	24V / 10A 36V / 6.7A 48V / 5A 60V / 4A		2.1Kg	Φ 191.5 x 69 □: suffix: A: IP65 adjustable B: IP67 dimming Otherwise: IP67





Desk Top Power Adapters				
Model	Output	Case	Weight	Dimensions
GST18A05-P1J GST18A07-P1J GST18A09-P1J GST18A12-P1J GST18A15-P1J GST18A18-P1J GST18A24-P1J GST18A28-P1J GST18A48-P1J	5V / 3A 7.5V / 2A 9V / 2A 12V / 1.5A 15V / 1.2A 18V / 1A 24V / 0.75A 28V / 0.64A 48V / 0.375A		0.21Kg	93 x 54 x 36 Level VI Energy MEPS approved
GST25A05-P1J GST25A07-P1J GST25A09-P1J GST25A12-P1J GST25A15-P1J GST25A18-P1J GST25A24-P1J GST25A28-P1J GST25A48-P1J	5V / 4A 7.5V / 2.93A 9V / 2.55A 12V / 2.08A 15V / 1.66A 18V / 1.38A 24V / 1.04A 28V / 0.89A 48V / 0.52A		0.21Kg	93 x 54 x 36 Level VI Energy MEPS approved

GST40A05-P1J GST40A07-P1J GST40A09-P1J GST40A12-P1J GST40A15-P1J GST40A18-P1J GST40A24-P1J GST40A48-P1J	5V / 5A 7.5V / 5.34A 9V / 4.45A 12V / 3.34A 15V / 2.67A 18V / 2.22A 24V / 1.67A 48V / 0.84A		0.28Kg	125 x 50 x 31.5 Level VI Energy MEPS approved
GST60A05-P1J GST60A07-P1J GST60A09-P1J GST60A12-P1J GST60A15-P1J GST60A18-P1J GST60A24-P1J GST60A48-P1J	5V / 6A 7.5V / 6A 9V / 6A 12V / 5A 15V / 4A 18V / 3.33A 24V / 2.5A 48V / 1.25A		0.31Kg	125 x 50 x 31.5 Level VI Energy MEPS approved
GST90A12-P1M GST90A15-P1M GST90A19-P1M GST90A24-P1M GST90A48-P1M	12V / 6.67A 15V / 6A 19V / 4.47A 24V / 3.75A 48V / 1.87A		0.45Kg	145 x 60 x 32 Level VI Energy MEPS approved
GST120A12-R7B GST120A15-R7B GST120A20-R7B GST120A24-R7B GST120A48-R7B	12V / 8.5A 15V / 7A 20V / 6A 24V / 5A 48V / 2.5A		0.62Kg	167 x 67 x 35 Level VI Energy MEPS approved
GST120A20-P1M GST120A24-P1M GST120A48-P1M	20V / 6A 24V / 5A 48V / 2.5A			
GST160A12-R7B GST160A15-R7B GST160A20-R7B GST160A24-R7B GST160A48-R7B	12V / 11.5A 15V / 9.6A 20V / 8A 24V / 6.67A 48V / 3.34A			
GST220A12-R7B GST220A15-R7B GST220A20-R7B GST220A24-R7B GST220A48-R7B	12V / 15A 15V / 13.4A 20V / 11A 24V / 9.2A 48V / 4.6A		1.1Kg	210 x 85 x 46 Level VI Energy MEPS approved
GST280A12-C6P GST280A15-C6P GST280A20-C6P GST280A24-C6P GST280A48-C6P	12V / 21A 15V / 17A 20V / 13A 24V / 11.67A 48V / 5.84A		1.25Kg	220 x 95 x 46 Level VI Energy MEPS approved

Wall Mount Power Adapters				
Model	Output	Case	Weight	Dimensions
GE12I05-P1J GE12I07-P1J GE12I09-P1J GE12I12-P1J GE12I15-P1J GE12I18-P1J GE12I24-P1J	5V / 2A 7V / 2A 9V / 1.33A 12V / 1A 15V / 0.8A 18V / 0.83A 24V / 0.625A		0.11Kg	70.7 x 40 x 38.8 Supplied with Australian plug only MEPS Approve
GE18I05-P1J GE18I07-P1J GE18I09-P1J GE18I12-P1J GE18I15-P1J GE18I18-P1J GE18I24-P1J GE18I48-P1J	5V / 2.4A 7V / 1.73A 9V / 2A 12V / 1.5A 15V / 1.2A 18V / 1A 24V / 0.75A 48V / 0.375A		0.15Kg	81 x 43 x 40.5 Supplied with Australian plug only MEPS Approved
GE24I05 GE24I07 GE24I09 GE24I12 GE24I15 GE24I18 GE24I24 GE24I48	5V / 3A 7V / 2A 9V / 2.22A 12V / 2A 15V / 1.6A 18V / 1.33A 24V / 1A 48V / 0.5A		0.27Kg	81 x 43 x 40.55 Supplied with Australian plug only MEPS Approved
GE30I12-P1J GE30I15-P1J GE30I18-P1J GE30I24-P1J	12V / 2.5A 15V / 2A 18V / 1.66A 24V / 1.25A		0.27Kg	81 x 43 x 40.5 Supplied with Australian plug only MEPS Approved

Power Adapter Accessories				
Model	Output	Case	Weight	Dimensions
YP35+YC12	-		0.2Kg	Mains IEC Cable 3-Pin AU plug + IEC320-C13 inlet
P1J-P1M	-		-	Adapter lead 20cm
CrossOver	-		-	Polarity crossover lead
P1JP-W10	-		-	Plug Extension Lead 10cm P1J plug 10cm extension with WIRES
P1JP-W30	-		-	Plug Extension Lead 30cm P1J plug 30cm extension with WIRES



P1JP-W200				Plug Extension Lead 200cm P1J plug 200cm extension with WIRES
P1JS-W10				Socket Extension Lead 10cm P1J socket 10cm extension with WIRES
P1JS-W30			Socket Extension Lead 30cm P1J socket 30cm extension with WIRES	
P1JS-W100	-		Socket Extension Lead 100cm P1J socket 100cm extension with WIRES	
P1JS-W200			Socket Extension Lead 200cm P1J socket 200cm extension with WIRES	
P1JP-P1JS200			P1J Plug with 200cm Socket Extension	
P1JP-P1JS200HD			P1J Plug with 200cm Socket Extension with High Current	
2P1J-P1JS	-			-
4P1J-P1JS	-		-	1 to 4 DC splitter 1 x P1J Socket to 4 x P1J PLUGS
8P1J-P1JS	-		-	1 to 8 DC splitter 1 x P1J Socket to 8 x P1J PLUGS



Battery Chargers				
Model	Output	Case	Weight	Dimensions
GC120A12-R7B GC120A24-R7B GC120A48-R7B	13.6V / 7.5A 27.2V / 4.42A 54.4V / 2.21A		0.62Kg	167 x 67 x 35 ESV Approved
PB-230-12 PB-230-24 PB-230-48	14.4 V / 16.0A 28.8 V / 8.0A 57.6 V / 4.0A		1.16Kg	190 x 96 x 49 ESV Approved
PB-300P-12 PB-300P-24 PB-300P-48	14.4V / 20.85A 28.8V / 10.5A 57.6V / 5.3A		1.8Kg	253 x 135 x 48.5 ESV Approved
PB-360P-12C	14.4V / 24.3A		1.85Kg	NO BOOST MODE!
PB-360P-12 PB-360P-24 PB-360P-48	14.4V / 24.3A 28.8V / 12.5A 57.6V / 6.25A			253 x 135 x 48.5 ESV Approved
PB-600-12 PB-600-24 PB-600-48	14.4V / 40.0A 28.8V / 21.0A 57.6V / 10.5A			



PB-1000-12 PB-1000-24 PB-1000-48	14.4V / 60.0A 28.8V / 34.7A 57.6V / 17.4A		3.5Kg	300 x 184 x 70 ESV Approved
RPB-1600-12 RPB-1600-24 RPB-1600-48	14.4V / 100.0A 28.8V / 55A 57.6V / 27.5A		1.8Kg	300 x 85 x 41 Industrial Use Only

Security Series Power Supplies





Model	Output	Case	Weight	Dimensions
AD-55A	13.8V / 4A & 13.4V / 0.23A (Charger)		0.57Kg	159 x 97 x 38 DC UPS with Charger
AD-55B	27.6V / 2A & 26.5V / 0.16A (Charger)			
AD-155A	13.8V / 11.5A & 13.8V / 0.5A (Charger)		1.0Kg	199 x 110x 50 DC UPS with Charger
AD-155B	27.6V / 5.5A & 27.1V / 0.5A (Charger)			
AD-155C	54V / 2.7A & 53.5V / 0.5A (Charger)			
PSC-35A-C	13.8V / 2.6A & 13.8V / 0.9A (Charger)		0.145Kg	86.4 x 59.6 x 30 DC UPS with Charger
PSC-35B-C	27.6V/ 1.3A & 27.6V/ 0.45A (Charger)			
PSC-35A-C	13.8V / 2.6A & 13.8V / 0.9A (Charger)		0.145Kg	86.4 x 59.6 x 30 DC UPS with Charger
PSC-35B-C	27.6V/ 1.3A & 27.6V/ 0.45A (Charger)			
PSC-100A-C	13.8V / 7.0A & 13.8V / 2.5A (Charger)		1.0Kg	130 x 85 x 37 DC UPS with Charger
PSC-100B-C	27.6V/ 3.50A & 27.6V/ 1.25A (Charger)			
PSC-160A-C	13.8V / 11.6A & 13.8V / 4.0A (Charger)		1.0Kg	155.4 x 85 x 37 DC UPS with Charger
PSC-160B-C	27.6V/ 5.8A & 27.6V/ 2.0A (Charger)			
SCP-35-12 SCP-35-24	13.8V / 2.6A 27.6V / 1.4A		0.37Kg	99 x 97 x 36
SCP-50-12 SCP-50-24	13.8V / 3.6A 27.6V / 1.8A		0.37Kg	129 x 98 x 38
SCP-75-12 SCP-75-24	13.8V / 5.4A 27.6V / 2.7A		0.37Kg	159 x 97 x 36

DRC-40A	13.8V / 2.9A & 13.8V / 1.00A (Charger)		0.3Kg	40 x 90 x 100 DC UPS with Charger
DRC-40B	27.6V / 1.45A & 27.6V / 0.50A (Charger)			
DRC-60A	13.8V / 4.3A & 13.8V / 1.5A (Charger)		0.3Kg	40 x 90 x 100 DC UPS with Charger
DRC-60B	27.6V / 2.15A & 27.6V / 0.75A (Charger)			
DRC-100A	13.8V / 7.0A & 13.8V / 2.50A (Charger)		0.37Kg	55 x 90 x 100 DC UPS with Charger
DRC-100B	27.6V / 3.5A & 27.6V / 1.25A (Charger)			

Modular Power Supplies				
Model	Output	Case	Weight	Dimensions
MP-450	450 Watts		-	-
MP-650	650 Watts		-	-
MP-1K0	1000 Watts		-	-





Encapsulated Open Frame Power Supplies				
Model	Output	Case	Weight	Dimensions
IRM-01-3.3 □ IRM-01-5 □ IRM-01-9 □ IRM-01-12 □ IRM-01-15 □ IRM-01-24 □	3.3V / 300mA 5V / 200mA 9V / 111mA 12V / 83mA 15V / 67mA 24V / 42mA		0.02Kg	□: suffix Blank: PCB Type, 4pins S: SMD Type
IRM-02-3.3 □ IRM-02-5 □ IRM-02-9 □ IRM-02-12 □ IRM-02-15 □ IRM-02-24 □	3.3V / 600mA 5V / 400mA 9V / 222mA 12V / 167mA 15V / 133mA 24V / 83mA		0.02Kg	□: suffix Blank: PCB Type, 4pins S: SMD Type
IRM-03-3.3 □ IRM-03-5 □ IRM-03-9 □ IRM-03-12 □ IRM-03-15 □ IRM-03-24 □	3.3V / 900mA 5V / 600mA 9V / 333mA 12V / 250mA 15V / 200mA 24V / 125mA		0.02Kg	□: suffix Blank: PCB Type, 4pins S: SMD Type



IRM-05-3.3 IRM-05-5 IRM-05-12 IRM-05-15 IRM-05-24	3.3V / 1.25A 5V / 1.0A 12V / 0.42A 15V / 0.33A 24V / 0.23A		0.04Kg	45.5 x 25.4 x 21.5 PCB Module Type 4 pins
PM-05-3.3 PM-05-5 PM-05-12 PM-05-15 PM-05-24	3.3V / 1.25A 5V / 1.0A 12V / 0.42A 15V / 0.33A 24V / 0.23A		0.085Kg	62.85 x 50 x 19.7 Medical PCB Module Type
IRM-10-3.3 IRM-10-5 IRM-10-12 IRM-10-15 IRM-10-24	3.3V / 2.5A 5V / 2.0A 12V / 0.85A 15V / 0.67A 24V / 0.42A		0.04Kg	45.7 x 25.4 x 21.5 PCB Module Type 4 pins
PM-10-3.3 PM-10-5 PM-10-12 PM-10-15 PM-10-24	3.3V / 2.5A 5V / 2.0A 12V / 0.85A 15V / 0.67A 24V / 0.42A		0.105Kg	70 x 50 x 22.7 Medical PCB Module Type
IRM-15-3.3 IRM-15-5 IRM-15-12 IRM-15-15 IRM-15-24	3.3V / 3.5A 5V / 3.0A 12V / 1.25A 15V / 1.0A 24V / 0.63A		0.059Kg	52.4 x 27.2 x 24 PCB Module Type 4 pins
PM-15-3.3 PM-15-5 PM-15-12 PM-15-15 PM-15-24	3.3V / 3.5A 5V / 3.0A 12V / 1.25A 15V / 1.0A 24V / 0.63A		0.14Kg	75 x 53 x 22.7 Medical PCB Module Type
IRM-20-3.3 IRM-20-5 IRM-20-12 IRM-20-15 IRM-20-24	3.3V / 4.5A 5V / 4.4A 12V / 1.8A 15V / 1.4A 24V / 0.9A		0.059Kg	52.4 x 27.2 x 24 PCB Module Type 4 pins
PM-20-3.3 PM-20-5 PM-20-12 PM-20-15 PM-20-24	3.3V / 4.5A 5V / 4.4A 12V / 1.8A 15V / 1.4A 24V / 0.92A		0.18Kg	94 x 56 x 22.7 Medical PCB Module Type
IRM-30-5 IRM-30-12 IRM-30-15 IRM-30-24 IRM-30-48	5V / 6.0A 12V / 2.5A 15V / 2.0A 24V / 1.3A 48V / 0.63A		0.109Kg	69.5 x 39 x 24 PCB Module Type 4 pins
IRM-30-5ST IRM-30-12ST IRM-30-15ST IRM-30-24ST IRM-30-48ST	5V / 6.0A 12V / 2.5A 15V / 2.0A 24V / 1.3A 48V / 0.63A		0.109Kg	91 x 39.5 x 28.5 ST: Screw Type







IRM-45-5 IRM-45-12 IRM-45-15 IRM-45-24 IRM-45-48	5V / 8.0A 12V / 3.8A 15V / 3.0A 24V / 1.9A 48V / 0.94A		0.109Kg	87 x 52 x 29.5 PCB Module Type 4 pins
IRM-45-5ST IRM-45-12ST IRM-45-15ST IRM-45-24ST IRM-45-48ST	5V / 8.0A 12V / 3.8A 15V / 3.0A 24V / 1.9A 48V / 0.94A		0.109Kg	109 x 52 x 33.5 ST: Screw Type
IRM-60-5 IRM-60-12 IRM-60-15 IRM-60-24 IRM-60-48	5V / 10.0A 12V / 5.0A 15V / 4.0A 24V / 2.5A 48V / 1.25A		0.109Kg	87 x 52 x 29.5 PCB Module Type 4 pins
IRM-60-5ST IRM-60-12ST IRM-60-15ST IRM-60-24ST IRM-60-48ST	5V / 10.0A 12V / 5.0A 15V / 4.0A 24V / 2.5A 48V / 1.25A		0.109Kg	109 x 52 x 33.5 ST: Screw Type

Open Frame Power Supplies				
Model	Output	Case	Weight	Dimensions
NFM-05-3.3 NFM-05-5 NFM-05-12 NFM-05-15 NFM-05-24	3.3V / 1.25A 5V / 1.0A 12V / 0.42A 15V / 0.33A 24V / 0.23A		0.03Kg	58 x 45 x 19.1 Medical On Board Type
PS-05-5 PS-05-12 PS-05-15 PS-05-24 PS-05-48	5V / 1.0A 12V / 0.45A 15V / 0.35A 24V / 0.22A 48V / 0.11A		0.05Kg	75 x 40 x 20
NFM-10-3.3 NFM-10-5 NFM-10-12 NFM-10-15 NFM-10-24	3.3V / 2.5A 5V / 2.0A 12V / 0.85A 15V / 0.67A 24V / 0.42A		0.045Kg	65 x 45 x 22 Medical On Board Type
NFM-15-3.3 NFM-15-5 NFM-15-12 NFM-15-15 NFM-15-24	3.3V / 3.5A 5V / 3.0A 12V / 1.25A 15V / 1.0A 24V / 0.63A		0.065Kg	70 x 48 x 22 Medical On Board Type
PS-15-5 PS-15-12 PS-15-15 PS-15-24 PS-15-48	5V / 2.8A 12V / 1.25A 15V / 1.0A 24V / 0.625A 48V / 0.313A		0.083Kg	94 x 49 x 25
NFM-20-3.3 NFM-20-5 NFM-20-12 NFM-20-15 NFM-20-24	3.3V / 4.5A 5V / 4.4A 12V / 1.8A 15V / 1.4 24V / 0.92A		0.09Kg	89 x 51 x 19.3 Medical On Board Type

EPS-25-24	24V / 1.05A		0.081Kg	76.2 x 50.8 x 24 Low Cost Green Power
PS-25-3.3 PS-25-5 PS-25-7.5 PS-25-12 PS-25-13.5 PS-25-15 PS-25-24 PS-25-27 PS-25-48	3.3V / 5.0A 5V / 5.0A 7.5V / 3.3A 12V / 2.1A 13.5V / 1.9A 15V / 1.7A 24V / 1.0A 27V / 0.9A 48V / 0.5A		0.14Kg	107 x 61 x 28
MPS-30-5 MPS-30-12 MPS-30-15 MPS-30-24 MPS-30-27 MPS-30-48	5V / 5.0A 12V / 2.5A 15V / 2.0A 24V / 1.2A 27V / 1.1A 48V / 0.6A		0.16Kg	101.6 x 65.8 x 23.5 Medical Type
EPS-35-12	12V / 3.0A		0.085Kg	76.2 x 50.8 x 24 Low Cost Green Power
PS-35-3.3 PS-35-5 PS-35-7.5 PS-35-12 PS-35-13.5 PS-35-15 PS-35-24 PS-35-48	3.3V / 6.0A 5V / 6.0A 7.5V / 4.7A 12V / 3.0A 13.5V / 2.6A 15V / 2.4A 24V / 1.5A 48V / 0.75A		0.124Kg	101.6 x 50.8 x 24
MPS-45-3.3 MPS-45-5 MPS-45-7.5 MPS-45-12 MPS-45-13.5 MPS-45-15 MPS-45-24 MPS-45-27 MPS-45-48	3.3V / 8.0A 5V / 8.0A 7.5V / 5.4A 12V / 3.7A 13.5V / 3.3A 15V / 3.0A 24V / 1.9A 27V / 1.7A 48V / 1.0A		0.18Kg	127 x 76 x 28 Medical Type
PS-45-3.3 PS-45-5 PS-45-7.5 PS-45-12 PS-45-13.5 PS-45-15 PS-45-24 PS-45-27 PS-45-48	3.3V / 8.0A 5V / 8.0A 7.5V / 5.4A 12V / 3.7A 13.5V / 3.3A 15V / 3.0A 24V / 1.9A 27V / 1.7A 48V / 1.0A		0.19Kg	127 x 76 x 28
LPS-50-3.3 LPS-50-5 LPS-50-12 LPS-50-15 LPS-50-24 LPS-50-48	3.3V / 10.0A 5V / 10.0A 12V / 4.2A 15V / 3.4A 24V / 2.1A 48V / 1.1A		0.26Kg	195 x 55 x 23







RPS-60-3.3 RPS-60-5 RPS-60-12 RPS-60-15 RPS-60-24 RPS-60-48	3.3V / 11.0A 5V / 11.0A 12V / 5.5A 15V / 4.4A 24V / 2.75A 48V / 1.375A		0.15Kg	101.6 x 50.8 x 29 Medical Type
MPS-65-3.3 MPS-65-5 MPS-65-7.5 MPS-65-12 MPS-65-13.5 MPS-65-15 MPS-65-24 MPS-65-27 MPS-65-48	3.3V / 12.0A 5V / 12.0A 7.5V / 8.0A 12V / 5.2A 13.5V / 4.7A 15V / 4.2A 24V / 2.7A 27V / 2.4A 48V / 1.35A		0.23Kg	127 x 76 x 42 Medical Type
PS-65-3.3 PS-65-5 PS-65-7.5 PS-65-12 PS-65-13.5 PS-65-15 PS-65-24 PS-65-27 PS-65-48	3.3V / 12.0A 5V / 12.0A 7.5V / 8.0A 12V / 5.2A 13.5V / 4.7A 15V / 4.2A 24V / 2.7A 27V / 2.4A 48V / 1.35A		0.21Kg	127 x 76 x 42
ELP-75-3.3-C ELP-75-5-C ELP-75-12-C ELP-75-15-C ELP-75-24-C ELP-75-36-C ELP-75-48-C	3.3V / 15.0A 5V / 15.0A 12V / 6.25A 15V / 5.0A 24V / 3.15A 36V / 2.1A 48V / 1.6A		0.54Kg	195 x 68.5 x 33 Green Power Optional without case Available

LPS-75-3.3 LPS-75-5 LPS-75-12 LPS-75-15 LPS-75-24 LPS-75-48	3.3V / 15.0A 5V / 15.0A 12V / 6.2A 15V / 5.0A 24V / 3.2A 48V / 1.56A		0.325Kg	222 x 55 x 30
RPS-75-3.3 RPS-75-5 RPS-75-12 RPS-75-15 RPS-75-24 RPS-75-36 RPS-75-48	3.3V / 20.0A 5V / 18.7A 12V / 8.3A 15V / 6.7A 24V / 4.2A 27V / 2.8A 48V / 2.1A		0.23Kg	127 x 76.2 x 31 Medical PCB Type
LPP-100-3.3 LPP-100-5 LPP-100-7.5 LPP-100-12 LPP-100-13.5 LPP-100-15 LPP-100-24 LPP-100-27 LPP-100-48	3.3V / 20.0A 5V / 20.0A 7.5V / 13.3A 12V / 8.4A 13.5V / 7.5A 15V / 6.7A 24V / 4.2A 27V / 3.8A 48V / 2.1A		0.52Kg	222 x 62 x 33.6

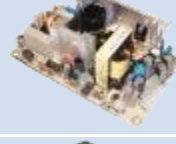

LPS-100-3.3 LPS-100-5 LPS-100-7.5 LPS-100-12 LPS-100-13.5 LPS-100-15 LPS-100-24 LPS-100-27 LPS-100-48	3.3V / 20.0A 5V / 20.0A 7.5V / 13.3A 12V / 8.4A 13.5V / 7.5A 15V / 6.7A 24V / 4.2A 27V / 3.8A 48V / 2.1A		0.579Kg	222 x 62 x 32
PPS-125-3.3 PPS-125-5 PPS-125-12 PPS-125-13.5 PPS-125-15 PPS-125-24 PPS-125-27 PPS-125-48	3.3V / 25.0A 5V / 25.0A 12V / 10.5A 13.5V / 9.3A 15V / 8.4A 24V / 5.2A 27V / 4.6A 48V / 2.6A		0.37Kg	127 x 76.2 x 34.6
ASP-150-12 ASP-150-15 ASP-150-20 ASP-150-24 ASP-150-48	12V / 11.0A 15V / 9.5A 20V / 7.5A 24V / 6.3A 48V / 3.2A		0.32Kg	169 x 60.7 x 28.5
LPP-150-3.3 LPP-150-5 LPP-150-7.5 LPP-150-12 LPP-150-13.5 LPP-150-15 LPP-150-24 LPP-150-27 LPP-150-48	3.3V / 30.0A 5V / 30.0A 7.5V / 20.0A 12V / 12.5A 13.5V / 11.2A 15V / 10.0A 24V / 6.3A 27V / 5.6A 48V / 3.2A		0.69Kg	222 x 75 x 41
RPS-160-5 RPS-160-12 RPS-160-15 RPS-160-24 RPS-160-48	5V / 30.0A 12V / 12.9A 15V / 10.3A 24V / 6.5A 48V / 3.25A		0.32Kg	127 x 76.2 x 34.6 Medical Type
MPS-200-3.3 MPS-200-5 MPS-200-12 MPS-200-15 MPS-200-24 MPS-200-48	3.3V / 40.0A 5V / 40.0A 12V / 16.7A 15V / 13.4A 24V / 8.4A 48V / 4.2A		0.66Kg	177.8 x 107.2 x 35.5
PPS-200-5 PPS-200-12 PPS-200-15 PPS-200-24 PPS-200-27 PPS-200-48	5V / 36.0A 12V / 16.6A 15V / 13.3A 24V / 8.3A 27V / 7.4A 48V / 4.167A		0.37Kg	127 x 76.2 x 35.1

RPS-300-12	12V / 25.0A		0.37Kg	127 x 76.2 x 35 Medical Type
RPS-300-15	15V / 20.0A			
RPS-300-24	24V / 12.5A			
RPS-300-27	27V / 11.12A			
RPS-300-48	48V / 6.25A			

Dual Rail Open Frame Power Supplies

Model	Output	Case	Weight	Dimensions
PD-25A	5V / 0.2-2.5A 12V / 0.1-1.5A		0.15Kg	107 x 61 x 28
PD-25B	5V / 0.2-2.0A 24V / 0.1-1.0A			
PD-2505	5V / 0.1-3.0A -5V / 0.1-2.5A			
PD-2512	12V / 0.1-1.2A -12V / 0.1-1.2A			
PD-2515	15V / 0.1-1.0A -15V / 0.1-1.0A			
PD-2503	3.3V / 0.2-5.0A 5V / 0.1-4.0A			
MPD-45A	5V / 0.4-5.0A 12V / 0.2-2.5A			
MPD-45B	5V / 0.4-5.0A 24V / 0.2-1.8A			
PD-45A	5V / 0.4-5.0A 12V / 0.2-2.5A		0.20Kg	127 x 76 x 28
PD-45B	5V / 0.4-5.0A 24V / 0.2-1.8A			
RPD-60A	5V / 0.5-5.5A 12V / 0.1-2.2A		0.15Kg	101.6 x 50.8 x 29 Medical Type
RPD-60B	5V / 0.5-3.85A 24V / 0.1-1.65A			
MPD-65A	5V / 0.4-7.0A 12V / 0.2-3.2A		0.25Kg	127 x 76 x 42 Medical Type
MPD-65B	5V / 0.4-6.0A 24V / 0.2-2.6A			
PD-65A	5V / 0.4-7.0A 12V / 0.2-3.2A		0.24Kg	127 x 76 x 42
PD-65B	5V / 0.4-6.0A 24V / 0.2-2.6A			
RPD-65C	12V / 0.0-5.8A 5V / 0.0-1.5A		0.24Kg	127 x 76 x 29 PCB Type
RPD-65D	24V / 0.0-2.9A 5V / 0.0-1.5A			
RPD-75A	5V / 1.0-9.5A 12V / 0.3-4.0A		0.23Kg	127 x 76.2 x 31 Medical Type
RPD-75B	5V / 1.0-6.8A 24V / 0.2-2.7A			

PD-110A	5V / 0.5-5.0A 12V / 0.5-6.5A		0.51Kg	178 x 108 x 46.5
PD-110B	5V / 0.5-5.0A 24V / 0.5-3.5A			
MPD-200A	5V / 4.0-24.0A 12V / 0.8-9.6A		0.66Kg	177.8 x 107.2 x 35.5 Medical Type
MPD-200B	5V / 4.0-24.0A 24V / 0.4-4.8A			
PID-250A	12V / 0.0-15.0A 5V / 0.0-5.0A		0.74Kg	222 x 95 x 40
PID-250B	24V / 0.0-9.4A 5V / 0.0-5.0A			
PID-250C	36V / 0.0-6.3A 5V / 0.0-5.0A			
PID-250D	48V / 0.0-4.7A 5V / 0.0-5.0A			

Triple Rail Open Frame Power Supplies				
Model	Output	Case	Weight	Dimensions
MPT-45A	5V / 0.4-5.0A 12V / 0.2-2.5A -5V / 0.0-0.5A		0.21Kg	127 x 76 x 2 Medical Type
MPT-45B	5V / 0.4-5.0A 12V / 0.2-2.5A -12V/ 0.0-0.5A			
MPT-45C	5V / 0.4-5.0A 15V / 0.2-2.3A -15V/ 0.0-0.5A			
PT-45A	5V / 0.4-5.0A 12V / 0.2-2.5A -5V / 0.0-0.5A		0.21Kg	127 x 76 x 28
PT-45B	5V / 0.4-5.0A 12V / 0.2-2.5A -12V/ 0.0-0.5A			
PT-45C	5V / 0.4-5.0A 15V / 0.2-2.3A -15V/ 0.0-0.5A			
PT-4503	3.3V / 0.0-5.0A 5V / 0.2-7.0A 12V/ 0.0-1.2A			
RPT-60A	5V / 0.5-4.4A 12V / 0.1-2.2A -5V / 0.1-0.55A		0.15Kg	101.6 x 50.8 x 29 Medical Type
RPT-60B	5V / 0.5-4.4A 12V / 0.1-2.2A -12V / 0.1-0.55A			
RPT-60C	5V / 0.5-4.4A 15V / 0.1-0.65A -15V / 0.1-0.55A			
RPT-60D	5V / 0.5-3.85A 24V / 0.1-1.1A 12V / 0.1-0.55A			
RPT-6003	3.3V / 0.5-5.5A 5V / 0.3-3.3A 12V / 0.1-0.77A			

MPT-65A	5V / 0.4-7.0A 12V / 0.2-3.2A -5V / 0.0-0.7A		0.27Kg	127 x 76 x 42 Medical Type
MPT-65B	5V / 0.4-7.0A 12V / 0.2-3.2A -12V / 0.0-0.7A			
MPT-65C	5V / 0.4-7.0A 15V / 0.2-2.6A -15V / 0.0-0.7A			
PT-65A	5V / 0.4-7.0A 12V / 0.2-3.2A -5V / 0.0-0.7A		0.25Kg	127 x 76 x 42
PT-65B	5V / 0.4-7.0A 12V / 0.2-3.2A -12V / 0.0-0.7A			
PT-65C	5V / 0.4-7.0A 15V / 0.2-2.6A -15V / 0.0-0.7A			
PT-65D	5V / 0.5-5.0A 12V / 0.2-4.0A 24V / 0.2-1.3A			
PT-6503	3.3V / 0.0-7.0A 5V / 0.2-10A 12V / 0.0-1.2A			
RPT-65E	12V / 0.18-5.8A 5V / 0-1.5A -5V / 0.0-0.7A		0.24Kg	127 x 76 x 29
RPT-65F	12V / 0.18-5.8A 5V / 0-1.5A -12V / 0.0-0.7A			
RPT-65G	24V / 0.09-2.9A 5V / 0-1.5A 12V / 0.0-0.7A			
RPT-75A	5V / 0.6-8.0A 12V / 0.2-4.0A -5V / 0.1-1.0A		0.23Kg	127 x 76.2 x 31 Medical Type
RPT-75B	5V / 0.6-8.0A 12V / 0.2-4.0A -12V / 0.1-1.0A			
RPT-75C	5V / 0.6-8.0A 15V / 0.1-3.0A -15V / 0.1-1.0A			
RPT-75D	5V / 0.6-7.0A 24V / 0.1-2.0A 12V / 0.1-1.0A			
PPT-125A	3.3V/1-12.5A 5V/0.8-10A 12V/ 0.05-0.63A		0.37Kg	127 x 76.2 x 34.6
PPT-125B	5V/ 1-14.38A 12V/ 0.3-3.75A -12V/ 0.05-0.63A			
PPT-125C	5V/ 1-13.75A 15V/ 0.25-3.13A -15V/ 0.05-0.63A			
PPT-125D	5V/ 1-8.75A, 24V/ 0.25-3.13A 12V/ 0.05-0.63A			

PT-200A	5V / 4.0-24.0A 12V / 0.8-9.0A -5V / 0.0-2.4A		0.66Kg	177.8 x 107.2 x 35.5 Medical Type
MPT-200B	5V / 4.0-24.0A 12V / 0.6-7.2A -12V / 0.0-2.4A			
MPT-200C	5V / 4.0-24.0A 15V / 0.5-5.6A -15V / 0.0-2.4A			
MPT-200D	5V / 4.0-24.0A 24V / 0.3-3.6A 12V / 0.0-2.4A			

Quad Rail Open Frame Power Supplies				
Model	Output	Case	Weight	Dimensions
MPQ-200B	5V / 3.0-18A 12V / 0.7-8.4A -5V / 0-2.4A -12V / 0-2.4A		0.66Kg	177.8 x 107.2 x 35.5 Medical Type
MPQ-200C	5V / 3.0-18A 15V / 0.5-6A -5V / 0-2.4A -15V / 0-2.4A			
MPQ-200D	5V / 3.0-18A 24V / 0.3-3.6A 12V / 0-2.4A -12V / 0-2.4A			
MPQ-200F	5V / 3.0-18A 24V / 0.3-3.3A 15V / 0-2.4A -15V / 0-2.4A			

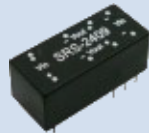
Module Type DC-DC Converter				
Model	Output	Case	Weight	Dimensions
SRS-0505	I/P 5V O/P 5V / 100mA		-	22.6 x 9.9 x 8.4
SRS-0509	I/P 5V O/P 9V / 56mA			
SRS-0512	I/P 5V O/P 12V / 42mA			
SRS-0515	I/P 5V O/P 15V / 34mA			
SRS-1205	I/P 12V O/P 5V / 100mA			
SRS-1209	I/P 12V O/P 9V / 56mA			
SRS-1212	I/P 12V O/P 12V / 42mA			
SRS-1215	I/P 12V O/P 15V / 34mA			
SRS-2405	I/P 24V O/P 5V / 100mA			
SRS-2409	I/P 24V O/P 9V / 56mA			
SRS-2412	I/P 24V O/P 12V / 42mA			
SRS-2415	I/P 24V O/P 15V / 34mA			
SRS-4805	I/P 48V O/P 5V / 100mA			
SRS-4809	I/P 48V O/P 9V / 56mA			
SRS-4812	I/P 48V O/P 12V / 42mA			
SRS-4815	I/P 48V O/P 15V / 34mA			

SUS01L-05	I/P 5V O/P 5V / 200mA		-	22.6 x 9.9 x 8.4
SUS01L-09	I/P 5V O/P 9V / 111mA			
SUS01L-12	I/P 5V O/P 12V / 84mA			
SUS01L-15	I/P 5V O/P 15V / 67mA			
SUS01M-05	I/P 12V O/P 5V / 200mA			
SUS01M-09	I/P 12V O/P 9V / 111mA			
SUS01M-12	I/P 12V O/P 12V / 84mA			
SUS01M-15	I/P 12V O/P 15V / 67mA			
SUS01N-05	I/P 24V O/P 5V / 200mA			
SUS01N-09	I/P 24V O/P 9V / 111mA			
SUS01N-12	I/P 24V O/P 12V / 84mA			
SUS01N-15	I/P 24V O/P 15V / 67mA			
SUS01O-05	I/P 48V O/P 5V / 200mA			
SUS01O-09	I/P 48V O/P 9V / 111mA			
SUS01O-12	I/P 48V O/P 12V / 84mA			
SUS01O-15	I/P 48V O/P 15V / 67mA			
SPR01L-05	I/P 5V O/P 5V / 200mA		-	19.6 x 7.1 x 10.14mm
SPR01L-09	I/P 5V O/P 9V / 100mA			
SPR01L-12	I/P 5V O/P 12V / 84mA			
SPR01L-15	I/P 5V O/P 15V / 67mA			
SPR01M-05	I/P 12V O/P 5V / 200mA			
SPR01M-09	I/P 12V O/P 9V / 100mA			
SPR01M-12	I/P 12V O/P 12V / 84mA			
SPR01M-15	I/P 12V O/P 15V / 67mA			
SPR01N-05	I/P 24V O/P 5V / 200mA			
SPR01N-09	I/P 24V O/P 9V / 100mA			
SPR01N-12	I/P 24V O/P 12V / 84mA			
SPR01N-15	I/P 24V O/P 15V / 67mA			
SPR01O-05	I/P 48V O/P 5V / 200mA			
SPR01O-09	I/P 48V O/P 9V / 100mA			
SPR01O-12	I/P 48V O/P 12V / 84mA			
SPR01O-15	I/P 48V O/P 15V / 67mA			
SMA01L-05	I/P 5V O/P 5V / 200mA		-	12.7 x 10.16 x 7.1
SMA01L-09	I/P 5V O/P 9V / 110mA			
SMA01L-12	I/P 5V O/P 12V / 84mA			
SMA01L-15	I/P 5V O/P 15V / 67mA			
SMA01M-05	I/P 12V O/P 5V / 200mA			
SMA01M-09	I/P 12V O/P 9V / 110mA			
SMA01M-12	I/P 12V O/P 12V / 84mA			
SMA01M-15	I/P 12V O/P 15V / 67mA			
SMA01N-05	I/P 24V O/P 5V / 200mA			
SMA01N-09	I/P 24V O/P 9V / 110mA			
SMA01N-12	I/P 24V O/P 12V / 84mA			
SMA01N-15	I/P 24V O/P 15V / 67mA			

SMU01L-05	I/P 5V O/P 5V / 200mA		-	11.6 x 6.10 x 10.14
SMU01L-09	I/P 5V O/P 9V / 110mA			
SMU01L-12	I/P 5V O/P 12V / 84mA			
SMU01L-15	I/P 5V O/P 15V / 67mA			
SMU01M-05	I/P 12V O/P 5V / 200mA		-	17.4 x 7.75 x 11.1
SMU01M-09	I/P 12V O/P 9V / 110mA			
SMU01M-12	I/P 12V O/P 12V / 84mA			
SMU01M-15	I/P 12V O/P 15V / 67mA			
SMU01N-05	I/P 24V O/P 5V / 200mA		-	12.7 x 11.2 x 4.13
SMU01N-09	I/P 24V O/P 9V / 110mA			
SMU01N-12	I/P 24V O/P 12V / 84mA			
SMU01N-15	I/P 24V O/P 15V / 67mA			
SPA01A-05	I/P 9-18V O/P 5V / 200mA		-	15.24 x 7.5 x 4.25
SPA01A-12	I/P 9-18V O/P 12V / 83mA			
SPA01A-15	I/P 9-18V O/P 15V / 67mA			
SPA01B-05	I/P 18-36V O/P 5V / 200mA		-	15.24 x 7.5 x 4.25
SPA01B-12	I/P 18-36V O/P 12V / 83mA			
SPA01B-15	I/P 18-36V O/P 15V / 67mA			
SPA01C-05	I/P 32-75V O/P 5V / 200mA		-	11.6 x 7.5 x 10.14
SPA01C-12	I/P 32-75V O/P 12V / 83mA			
SPA01C-15	I/P 32-75V O/P 15V / 67mA			
SFT01L-05	I/P 5V O/P 5V / 200mA		-	11.6 x 7.5 x 10.14
SFT01L-09	I/P 5V O/P 9V / 111mA			
SFT01L-12	I/P 5V O/P 12V / 84mA			
SFT01L-15	I/P 5V O/P 15V / 67mA			
SFT01M-05	I/P 12V O/P 5V / 200mA		-	15.24 x 7.5 x 4.25
SFT01M-12	I/P 12V O/P 12V / 84mA			
SFT01M-15	I/P 12V O/P 15V / 67mA			
DET01L-05	I/P 5V O/P ± 5V / ±100mA		-	15.24 x 7.5 x 4.25
DET01L-09	I/P 5V O/P ±9V / ±56mA			
DET01L-12	I/P 5V O/P ±12V / ±42mA			
DET01L-15	I/P 5V O/P ±15V / ±33mA			
DET01M-15	I/P 12V O/P ±15V / ±33mA			
SMU02L-05	I/P 5V O/P 5V / 400mA		-	11.6 x 7.5 x 10.14
SMU02L-12	I/P 5V O/P 12V / 167mA			
SMU02L-15	I/P 5V O/P 15V / 133mA			
SMU02M-05	I/P 12V O/P 5V / 400mA			
SMU02M-12	I/P 12V O/P 12V / 167mA			
SMU02M-15	I/P 12V O/P 15V / 133mA			
SMU02N-05	I/P 24V O/P 5V / 400mA			
SMU02N-12	I/P 24V O/P 12V / 167mA			
SMU02N-15	I/P 24V O/P 15V / 133mA			

SPU02L-05	I/P 5V O/P 5V / 400mA		-	19.6 x 7.1 x 10.14
SPU02L-12	I/P 5V O/P 12V / 167mA			
SPU02L-15	I/P 5V O/P 15V / 133mA			
SPU02M-05	I/P 12V O/P 5V / 400mA			
SPU02M-12	I/P 12V O/P 12V / 167mA			
SPU02M-15	I/P 12V O/P 15V / 133mA			
SPU02N-05	I/P 24V O/P 5V / 400mA			
SPU02N-12	I/P 24V O/P 12V / 167mA			
SPU02N-15	I/P 24V O/P 15V / 133mA			
SPA02E-05	I/P 4.5-9V O/P 5V / 400mA		-	21.8 x 9.2 x 11.1
SPA02E-12	I/P 4.5-9V O/P 12V / 150mA			
SPA02E-15	I/P 4.5-9V O/P 15V / 120mA			
SPA02A-05	I/P 9-18V O/P 5V / 400mA			
SPA02A-12	I/P 9-18V O/P 12V / 167mA			
SPA02A-15	I/P 9-18V O/P 15V / 133mA			
SPA02B-05	I/P 18-36V O/P 5V / 400mA			
SPA02B-12	I/P 18-36V O/P 12V / 167mA			
SPA02B-15	I/P 18-36V O/P 15V / 133mA			
SPA02C-05	I/P 32-72V O/P 5V / 400mA		-	21.8 x 9.2 x 11.1
SPA02C-12	I/P 32-72V O/P 12V / 167mA			
SPA02C-15	I/P 32-72V O/P 15V / 133mA			
SPB03E-05	I/P 4.5-9V O/P 5V / 600mA			
SPB03E-12	I/P 4.5-9V O/P 12V / 250mA			
SPB03E-15	I/P 4.5-9V O/P 15V / 200mA			
SPB03A-05	I/P 9-18V O/P 5V / 600mA			
SPB03A-12	I/P 9-18V O/P 12V / 250mA			
SPB03A-15	I/P 9-18V O/P 15V / 200mA			
SPB03B-05	I/P 18-36V O/P 5V / 600mA		-	19.6 x 7.5 x 10.14
SPB03B-12	I/P 18-36V O/P 12V / 250mA			
SPB03B-15	I/P 18-36V O/P 15V / 200mA			
SPB03C-05	I/P 32-72V O/P 5V / 600mA			
SPB03C-12	I/P 32-72V O/P 12V / 250mA			
SPB03C-15	I/P 32-72V O/P 15V / 200mA			
SPU03L-05	I/P 5V O/P 5V / 600mA			
SPU03L-12	I/P 5V O/P 12V / 250mA			
SPU03L-15	I/P 5V O/P 15V / 200mA			
SPU03M-05	I/P 12V O/P 5V / 600mA		-	31.8 x 20.3 x 12.2
SPU03M-12	I/P 12V O/P 12V / 250mA			
SPU03M-15	I/P 12V O/P 15V / 200mA			
SPU03N-05	I/P 24V O/P 5V / 600mA			
SPU03N-12	I/P 24V O/P 12V / 250mA			
SPU03N-15	I/P 24V O/P 15V / 200mA			
SCW03A-05	I/P 9-18V O/P 5V / 600mA			
SCW03A-12	I/P 9-18V O/P 12V / 250mA			
SCW03A-15	I/P 9-18V O/P 15V / 200mA			
SCW03B-05	I/P 18-36V O/P 5V / 600mA		-	
SCW03B-12	I/P 18-36V O/P 12V / 250mA			
SCW03B-15	I/P 18-36V O/P 15V / 200mA			
SCW03C-05	I/P 36-72V O/P 5V / 600mA			
SCW03C-12	I/P 36-72V O/P 12V / 250mA			
SCW03C-15	I/P 36-72V O/P 15V / 200mA			

DCW03A-05	I/P 9-18V O/P $\pm 5V / \pm 300mA$		-	31.8 x 20.3 x 12.2
DCW03A-12	I/P 9-18V O/P $\pm 12V / \pm 125mA$			
DCW03A-15	I/P 9-18V O/P $\pm 15V / \pm 100mA$			
DCW03B-05	I/P 18-36V O/P $\pm 5V / \pm 300mA$			
DCW03B-12	I/P 18-36V O/P $\pm 12V / \pm 125mA$			
DCW03B-15	I/P 18-36V O/P $\pm 15V / \pm 100mA$			
DCW03C-05	I/P 36-72V O/P $\pm 5V / \pm 300mA$		-	31.8 x 20.3 x 12.2
DCW03C-12	I/P 36-72V O/P $\pm 12V / \pm 125mA$			
DCW03C-15	I/P 36-72V O/P $\pm 15V / \pm 100mA$			
SCW05A-05	I/P 9-18V O/P 5V / 1000mA			
SCW05A-09	I/P 9-18V O/P 9V / 556mA			
SCW05A-12	I/P 9-18V O/P 12V / 470mA			
SCW05A-15	I/P 9-18V O/P 15V / 400mA		-	31.8 x 20.3 x 12.2
SCW05B-05	I/P 18-36V O/P 5V / 1000mA			
SCW05B-09	I/P 18-36V O/P 9V / 556mA			
SCW05B-12	I/P 18-36V O/P 12V / 470mA			
SCW05B-15	I/P 18-36V O/P 15V / 400mA			
SCW05C-05	I/P 36-72V O/P 5V / 1000mA			
SCW05C-09	I/P 36-72V O/P 9V / 556mA			
SCW05C-12	I/P 36-72V O/P 12V / 470mA			
SCW05C-15	I/P 36-72V O/P 15V / 400mA		-	31.8 x 20.3 x 12.2
DCW05A-05	I/P 9-18V O/P $\pm 5V / \pm 500mA$			
DCW05A-12	I/P 9-18V O/P $\pm 12V / \pm 230mA$			
DCW05A-15	I/P 9-18V O/P $\pm 15V / \pm 190mA$			
DCW05B-05	I/P 18-36V O/P $\pm 5V / \pm 500mA$			
DCW05B-12	I/P 18-36V O/P $\pm 12V / \pm 230mA$			
DCW05B-15	I/P 18-36V O/P $\pm 15V / \pm 190mA$			
DCW05C-05	I/P 36-72V O/P $\pm 5V / \pm 500mA$		-	31.8 x 20.3 x 12.2
DCW05C-12	I/P 36-72V O/P $\pm 12V / \pm 230mA$			
DCW05C-15	I/P 36-72V O/P $\pm 15V / \pm 190mA$			
SLW05A-05	I/P 9-18V O/P 5V / 1000mA			
SLW05A-09	I/P 9-18V O/P 9V / 556mA			
SLW05A-12	I/P 9-18V O/P 12V / 417mA			
SLW05A-15	I/P 9-18V O/P 15V / 333mA		-	50.8 x 25.4 x 11.27
SLW05B-05	I/P 18-36V O/P 5V / 1000mA			
SLW05B-09	I/P 18-36V O/P 9V / 556mA			
SLW05B-12	I/P 18-36V O/P 12V / 417mA			
SLW05B-15	I/P 18-36V O/P 15V / 333mA			
SLW05C-05	I/P 36-72V O/P 5V / 1000mA			
SLW05C-09	I/P 36-72V O/P 9V / 556mA			
SLW05C-12	I/P 36-72V O/P 12V / 417mA			
SLW05C-15	I/P 36-72V O/P 15V / 333mA		-	50.8 x 25.4 x 11.27
DLW05A-05	I/P 9-18V O/P $\pm 5V / \pm 500mA$			
DLW05A-12	I/P 9-18V O/P $\pm 12V / \pm 208mA$			
DLW05A-15	I/P 9-18V O/P $\pm 15V / \pm 167mA$			
DLW05B-05	I/P 18-36V O/P $\pm 5V / \pm 500mA$			
DLW05B-12	I/P 18-36V O/P $\pm 12V / \pm 208mA$			
DLW05B-15	I/P 18-36V O/P $\pm 15V / \pm 167mA$			
DLW05C-05	I/P 36-72V O/P $\pm 5V / \pm 500mA$		-	50.8 x 25.4 x 11.27
DLW05C-12	I/P 36-72V O/P $\pm 12V / \pm 208mA$			
DLW05C-15	I/P 36-72V O/P $\pm 15V / \pm 167mA$			

SCW08A-05	I/P 9-18V O/P 5V / 1600mA		-	31.8 x 20.3 x 12.2
SCW08A-12	I/P 9-18V O/P 12V / 670mA			
SCW08A-15	I/P 9-18V O/P 15V / 533mA			
SCW08B-05	I/P 18-36V O/P 5V / 1600mA			
SCW08B-12	I/P 18-36V O/P 12V / 670mA			
SCW08B-15	I/P 18-36V O/P 15V / 533mA			
SCW08C-05	I/P 36-72V O/P 5V / 1600mA			
SCW08C-12	I/P 36-72V O/P 12V / 670mA			
SCW08C-15	I/P 36-72V O/P 15V / 533mA			
DCW08A-05	I/P 9-18V O/P ±5V / ±800mA		-	31.8 x 20.3 x 12.2
DCW08A-12	I/P 9-18V O/P ±12V / ±335mA			
DCW08A-15	I/P 9-18V O/P ±15V / ±267mA			
DCW08B-05	I/P 18-36V O/P ±5V / ±800mA			
DCW08B-12	I/P 18-36V O/P ±12V / ±335mA			
DCW08B-15	I/P 18-36V O/P ±15V / ±267mA			
DCW08C-05	I/P 36-72V O/P ±5V / ±800mA			
DCW08C-12	I/P 36-72V O/P ±12V / ±335mA			
DCW08C-15	I/P 36-72V O/P ±15V / ±267mA			
SKE10A-05	I/P 9-18V O/P 5V / 2000mA		-	50.8 x 25.4 x 11.27
SKE10A-12	I/P 9-18V O/P 12V / 840mA			
SKE10A-15	I/P 9-18V O/P 15V / 666mA			
SKE10A-24	I/P 9-18V O/P 24V / 420mA			
SKE10B-05	I/P 18-36V O/P 5V / 2000mA			
SKE10B-12	I/P 18-36V O/P 12V / 840mA			
SKE10B-15	I/P 18-36V O/P 15V / 666mA			
SKE10B-24	I/P 18-36V O/P 24V / 420mA			
SKE10C-05	I/P 36-72V O/P 5V / 2000mA			
SKE10C-12	I/P 36-72V O/P 12V / 840mA			
SKE10C-15	I/P 36-72V O/P 15V / 666mA			
SKE10C-24	I/P 36-72V O/P 24V / 420mA			
DKE10A-05	I/P 9-18V O/P ±5V / ±1000mA		-	50.8 x 25.4 x 11.27
DKE10A-12	I/P 9-18V O/P ±12V / ±420mA			
DKE10A-15	I/P 9-18V O/P ±15V / ±333mA			
DKE10A-24	I/P 9-18V O/P ±24V / ±210mA			
DKE10B-05	I/P 18-36V O/P ±5V / ±1000mA			
DKE10B-12	I/P 18-36V O/P ±12V / ±420mA			
DKE10B-15	I/P 18-36V O/P ±15 / ±333mA			
DKE10B-24	I/P 18-36V O/P ±24V / ±210mA			
DKE10C-05	I/P 36-72V O/P ±5V / ±1000mA			
DKE10C-12	I/P 36-72V O/P ±12V / ±420mA			
DKE10C-15	I/P 36-72V O/P ±15V / ±333mA			
DKE10C-24	I/P 36-72V O/P ±24V / ±210mA			
SCW12A-05	I/P 9-18V O/P 5V / 2400mA		-	31.8 x 20.3 x 12.2
SCW12A-12	I/P 9-18V O/P 12V / 1000mA			
SCW12A-15	I/P 9-18V O/P 15V / 800mA			
SCW12B-05	I/P 18-36V O/P 5V / 2400mA			
SCW12B-12	I/P 18-36V O/P 12V / 1000mA			
SCW12B-15	I/P 18-36V O/P 15V / 800mA			
SCW12C-05	I/P 36-72V O/P 5V / 2400mA			
SCW12C-12	I/P 36-72V O/P 12V / 1000mA			
SCW12C-15	I/P 36-72V O/P 15V / 800mA			



DCW12A-05	I/P 9-18V O/P ±5V / ±1200mA		-	31.8 x 20.3 x 12.2
DCW12A-12	I/P 9-18V O/P ±12V / ±500mA			
DCW12A-15	I/P 9-18V O/P ±15V / ±400mA			
DCW12B-05	I/P 18-36V O/P ±5V / ±1200mA			
DCW12B-12	I/P 18-36V O/P ±12V / ±500mA			
DCW12B-15	I/P 18-36V O/P ±15V / ±400mA			
DCW12C-05	I/P 36-72V O/P ±5V / ±1200mA			
DCW12C-12	I/P 36-72V O/P ±12V / ±500mA			
DCW12C-15	I/P 36-72V O/P ±15V / ±400mA			
SKA15A-033	I/P 9-18V O/P 3.3V / 3000mA		-	50.8 x 25.4 x 11.27
SKA15A-05	I/P 9-18V O/P 5V / 3000mA			
SKA15A-12	I/P 9-18V O/P 12V / 1250mA			
SKA15A-15	I/P 9-18V O/P 15V / 1000mA			
SKA15B-033	I/P 18-36V O/P 3.3V / 3000mA			
SKA15B-05	I/P 18-36V O/P 5V / 3000mA			
SKA15B-12	I/P 18-36V O/P 12V / 1250mA			
SKA15B-15	I/P 18-36V O/P 15V / 1000mA			
SKA15C-033	I/P 36-72V O/P 3.3V / 3000mA			
SKA15C-05	I/P 36-72V O/P 5V / 3000mA			
SKA15C-12	I/P 36-72V O/P 12V / 1250mA			
SKA15C-15	I/P 36-72V O/P 15V / 1000mA			
DKA15A-05	I/P 9-18V O/P ±5V / ±1500mA		-	50.8 x 25.4 x 11.27
DKA15A-12	I/P 9-18V O/P ±12V / ±625mA			
DKA15A-15	I/P 9-18V O/P ±15V / ±500mA			
DKA15B-05	I/P 18-36V O/P ±5V / ±1500mA			
DKA15B-12	I/P 18-36V O/P ±12V / ±625mA			
DKA15B-15	I/P 18-36V O/P ±15V / ±500mA			
DKA15C-05	I/P 36-72V O/P ±5V / ±1500mA			
DKA15C-12	I/P 36-72V O/P ±12V / ±625mA			
DKA15C-15	I/P 36-72V O/P ±15V / ±500mA			
SKE15A-05	I/P 9-18V O/P 5V / 3000mA		-	50.8 x 50.8 x 11
SKE15A-12	I/P 9-18V O/P 12V / 1250mA			
SKE15A-15	I/P 9-18V O/P 15V / 1000mA			
SKE15A-24	I/P 9-18V O/P 24V / 625mA			
SKE15B-05	I/P 18-36V O/P 5V / 3000mA			
SKE15B-12	I/P 18-36V O/P 12V / 1250mA			
SKE15B-15	I/P 18-36V O/P 15V / 1000mA			
SKE15B-24	I/P 18-36V O/P 24V / 625mA			
SKE15C-05	I/P 36-72V O/P 5V / 3000mA			
SKE15C-12	I/P 36-72V O/P 12V / 1250mA			
SKE15C-15	I/P 36-72V O/P 15V / 1000mA			
SKE15C-24	I/P 36-72V O/P 24V / 625mA			

DKE15A-05	I/P 9-18V O/P ±5V / ±1500mA		-	50.8 x 50.8 x 11
DKE15A-12	I/P 9-18V O/P ±12V / ±625mA			
DKE15A-15	I/P 9-18V O/P ±15V / ±500mA			
DKE15A-24	I/P 9-18V O/P ±24V / ±313mA			
DKE15B-05	I/P 18-36V O/P ±5V / ±1500mA		-	25.4 x 25.4 x 9.9
DKE15B-12	I/P 18-36V O/P ±12V / ±625mA			
DKE15B-15	I/P 18-36V O/P ±15V / ±500mA			
DKE15B-24	I/P 18-36V O/P ±24V / ±313mA			
DKE15C-05	I/P 36-72V O/P ±5V / ±1500mA		-	50.8 x 25.4 x 11.2
DKE15C-12	I/P 36-72V O/P ±12V / ±625mA			
DKE15C-15	I/P 36-72V O/P ±15V / ±500mA			
DKE15C-24	I/P 36-72V O/P ±24V / ±313mA			
SKM15A-05	I/P 9-18V O/P 5V / 3000mA		-	50.8 x 50.8 x 16
SKM15A-12	I/P 9-18V O/P 12V / 1250mA			
SKM15A-15	I/P 9-18V O/P 15V / 1000mA			
SKM15B-05	I/P 18-36V O/P 5V / 3000mA			
SKM15B-12	I/P 18-36V O/P 12V / 1250mA		-	50.8 x 25.4 x 11.2
SKM15B-15	I/P 18-36V O/P 15V / 1000mA			
SKM15C-05	I/P 36-75V O/P 5V / 3000mA			
SKM15C-12	I/P 36-75V O/P 12V / 1250mA			
SKM15C-15	I/P 36-75V O/P 15V / 1000mA			
SKA20A-05	I/P 9-18V O/P 5V / 4000mA		-	50.8 x 25.4 x 11.2
SKA20A-12	I/P 9-18V O/P 12V / 1666mA			
SKA20A-15	I/P 9-18V O/P 15V / 1333mA			
SKA20B-05	I/P 18-36V O/P 5V / 4000mA			
SKA20B-12	I/P 18-36V O/P 12V / 1666mA		-	50.8 x 25.4 x 11.2
SKA20B-15	I/P 18-36V O/P 15V / 1333mA			
SKA20C-05	I/P 36-75V O/P 5V / 4000mA			
SKA20C-12	I/P 36-75V O/P 12V / 1666mA			
SKA20C-15	I/P 36-75V O/P 15V / 1333mA			
SDM30-12S3	I/P 9.2-18V O/P 3.3V / 5A		-	50.8 x 50.8 x 16
SDM30-12S5	I/P 9.2-18V O/P 5V / 5A			
SDM30-12S12	I/P 9.2-18V O/P 12V / 2.1A			
SDM30-12S15	I/P 9.2-18V O/P 15V / 1.7A			
SDM30-24S3	I/P 18-36V O/P 3.3V / 5A		-	50.8 x 50.8 x 16
SDM30-24S5	I/P 18-36V O/P 5V / 5A			
SDM30-24S12	I/P 18-36V O/P 12V / 2.5A			
SDM30-24S15	I/P 18-36V O/P 15V / 2.0A			
SDM30-48S3	I/P 36-72V O/P 3.3V / 5A		-	50.8 x 50.8 x 16
SDM30-48S5	I/P 36-72V O/P 5V / 5A			
SDM30-48S12	I/P 36-72V O/P 12V / 2.5A			
SDM30-48S15	I/P 36-72V O/P 15V / 2.0A			
SKM30A-05	I/P 9-18V O/P 5V / 6A		-	50.8 x 25.4 x 11.2
SKM30A-12	I/P 9-18V O/P 12V / 2.5A			
SKM30A-15	I/P 9-18V O/P 15V / 2.0A			
SKM30B-05	I/P 18-36V O/P 5V / 6A			
SKM30B-12	I/P 18-36V O/P 12V / 2.5A		-	50.8 x 25.4 x 11.2
SKM30B-15	I/P 18-36V O/P 15V / 2.0A			
SKM30C-05	I/P 36-75V O/P 5V / 6.0A			
SKM30C-12	I/P 36-75V O/P 12V / 2.5A			
SKM30C-15	I/P 36-75V O/P 15V / 2.0A			

DKA30A-05 DKA30A-12 DKA30A-15	I/P 9-18V O/P ±5V / ±2500mA I/P 9-18V O/P ±12V / ±1250mA I/P 9-18V O/P ±15V / ±1000mA		-	50.8 x 50.8 x 21			
DKA30B-05 DKA30B-12 DKA30B-15	I/P 18-36V O/P ±5V / ±2500mA I/P 18-36V O/P ±12V / ±1250mA I/P 18-36V O/P ±15V / ±1000mA						
DKA30C-05 DKA30C-12 DKA30C-15	I/P 36-72V O/P ±5V / ±2500mA I/P 36-72V O/P ±12V / ±1250mA I/P 36-72V O/P ±15V / ±1000mA						
TKA30A-B TKA30A-C	I/P 9-18V O/P 5V / 3500mA & ±12V / ±310mA I/P 9-18V O/P 5V / 3500mA & ±15V / ±250mA						
TKA30B-B TKA30B-C	I/P 18-36V O/P 5V / 3500mA & ±12V / ±310mA I/P 18-36V O/P 5V / 3500mA & ±15V / ±250mA					-	50.8 x 50.8 x 21
TKA30C-B TKA30C-C	I/P 36-72V O/P 5V / 3500mA & ±12V / ±310mA I/P 36-72V O/P 5V / 3500mA & ±15V / ±250mA						
SKA40A-05 SKA40A-12 SKA40A-15	I/P 9-18V O/P 5V / 7.0A I/P 9-18V O/P 12V / 3.33A I/P 9-18V O/P 15V / 2.67A		-	50.8 x 50.8 x 11			
SKA40B-05 SKA40B-12 SKA40B-15	I/P 18-36V O/P 5V / 7.0A I/P 18-36V O/P 12V / 3.33A I/P 18-36V O/P 15V / 2.67A						
SKA40C-05 SKA40C-12 SKA40C-15	I/P 36-75V O/P 5V / 7.0A I/P 36-75V O/P 12V / 3.33A I/P 36-75V O/P 15V / 2.67A						
SKM50B-05 SKM50B-12 SKM50B-15	I/P 18-36V O/P 5V / 10.0A I/P 18-36V O/P 12V / 4.17A I/P 18-36V O/P 15V / 3.33A					-	50.8 x 25.4 x 13.7
SKM50C-05 SKM50C-12 SKM50C-15	I/P 36-75V O/P 5V / 10.0A I/P 36-75V O/P 12V / 4.17A I/P 36-75V O/P 15V / 3.33A						
SKA60A-05 SKA60A-12 SKA60A-15	I/P 9-18V O/P 5V / 12.0A I/P 9-18V O/P 12V / 5.0A I/P 9-18V O/P 15V / 4.0A						
SKA60B-05 SKA60B-12 SKA60B-15	I/P 18-36V O/P 5V / 12.0A I/P 18-36V O/P 12V / 5.0A I/P 18-36V O/P 15V / 4.0A						
SKA60C-05 SKA60C-12 SKA60C-15	I/P 36-75V O/P 5V / 12.0A I/P 36-75V O/P 12V / 5.0A I/P 36-75V O/P 15V / 4.0A						

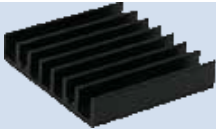
PCB Type DC-DC Converter							
Model	Output	Case	Weight	Dimensions			
NSD05-12S3 NSD05-12S5 NSD05-12S12 NSD05-12S15	I/P 9.2-36V O/P 3.3V / 1200mA I/P 9.2-36V O/P 5V / 1000mA I/P 9.2-36V O/P 12V / 420mA I/P 9.2-36V O/P 15V / 330mA		-	40.6 x 25.4 x 8.3			
NSD05-48S3 NSD05-48S5 NSD05-48S12 NSD05-48S15	I/P 18-72V O/P 3.3V / 1200mA I/P 18-72V O/P 5V / 1000mA I/P 18-72V O/P 12V / 420mA I/P 18-72V O/P 15V / 330mA						
NSD10-12S3 NSD10-12S5 NSD10-12S9 NSD10-12S12 NSD10-12S15	I/P 9.8-36V O/P 3.3V / 2500mA I/P 9.8-36V O/P 5V / 2000mA I/P 9.8-36V O/P 9V / 1100mA I/P 9.8-36V O/P 12V / 830mA I/P 9.8-36V O/P 15V / 670mA					-	50.8 x 38.1 x 9.82mm
NSD10-48S3 NSD10-48S5 NSD10-48S9 NSD10-48S12 NSD10-48S15	I/P 22-72V O/P 3.3V / 2500mA I/P 22-72V O/P 5V / 2000mA I/P 22-72V O/P 9V / 1100mA I/P 22-72V O/P 12V / 830mA I/P 22-72V O/P 15V / 670mA						
NSD10-12D5 NSD10-12D12 NSD10-12D15	I/P 9.8-36V O/P ±5V / 50-1000mA I/P 9.8-36V O/P ±12V / 20-420mA I/P 9.8-36V O/P ±15V / 16-330mA						
NSD10-48D5 NSD10-48D12 NSD10-48D15	I/P 22-72V O/P ±5V / 50-1000mA I/P 22-72V O/P ±12V / 20-420mA I/P 22-72V O/P ±15V / 16-330mA						
NSD15-12S3 NSD15-12S5 NSD15-12S12 NSD15-12S15	I/P 9.4-36V O/P 3.3V / 3750mA I/P 9.4-36V O/P 5V / 3000mA I/P 9.4-36V O/P 12V / 1250mA I/P 9.4-36V O/P 15V / 1000mA		-	50.8 x 25.4 x 10mm			
NSD15-48S3 NSD15-48S5 NSD15-48S12 NSD15-48S15	I/P 18-72V O/P 3.3V / 3750mA I/P 18-72V O/P 5V / 3000mA I/P 18-72V O/P 12V / 1250mA I/P 18-72V O/P 15V / 1000mA						
NSD15-12D5 NSD15-12D12 NSD15-12D15	I/P 9.4-36V O/P ±5V / 70-1500mA I/P 9.4-36V O/P ±12V / 30-620mA I/P 9.4-36V O/P ±15V / 20-500mA						
NSD15-48D5 NSD15-48D12 NSD15-48D15	I/P 18-72V O/P ±5V / 70-1500mA I/P 18-72V O/P ±12V / 30-620mA I/P 18-72V O/P ±15V / 20-500mA						

Half Brick Type DC-DC Converter				
Model	Output	Case	Weight	Dimensions
MHB75-12S05	I/P 9-18V O/P 5V / 15.0A		-	
MHB75-12S12	I/P 9-18V O/P 12V / 6.25A			
MHB75-12S24	I/P 9-18V O/P 24V / 3.13A			
MHB75-24S05	I/P 18-36V O/P 5V / 15.0A			
MHB75-24S12	I/P 18-36V O/P 12V / 6.25A			
MHB75-24S24	I/P 18-36V O/P 24V / 3.13A			
MHB75-48S05	I/P 36-75V O/P 5V / 15.0A			
MHB75-48S12	I/P 36-75V O/P 12V / 6.25A			
MHB75-48S24	I/P 36-75V O/P 24V / 3.13A			
MHB100-24S05	I/P 18-36V O/P 5V / 20.0A			
MHB100-24S12	I/P 18-36V O/P 12V / 8.3A			
MHB100-24S24	I/P 18-36V O/P 24V / 4.17A			
MHB100-48S05	I/P 36-75V O/P 5V / 20.0A			
MHB100-48S12	I/P 36-75V O/P 12V / 8.3A			
MHB100-48S24	I/P 36-75V O/P 24V / 4.17A			
MHB150-48S05	I/P 36-75V O/P 5V / 30.0A			
MHB150-48S12	I/P 36-75V O/P 12V / 12.5A			
MHB150-48S24	I/P 36-75V O/P 24V / 6.25A			
M-C308	Vertical Fins Heat Sink		-	For MHB Series
M-C091	Horizontal Fins Heat Sink			
M-C092	Horizontal Fins Heat Sink			

Open Frame DC-DC Converter				
Model	Output	Case	Weight	Dimensions
PSD-05-5	I/P 36-72V O/P 5V / 1.0A		-	75 x 40 x 20
PSD-05-12	I/P 36-72V O/P 12V / 0.45A			
PSD-05-24	I/P 36-72V O/P 24V / 0.22A			
PSD-15A-5	I/P 9.2-18V O/P 5V / 3.0A		-	94 x 49 x 25
PSD-15A-12	I/P 9.2-18V O/P 12V / 1.25A			
PSD-15A-24	I/P 9.2-18V O/P 24V / 0.6A			
PSD-15B-5	I/P 18-36V O/P 5V / 3.0A			
PSD-15B-12	I/P 18-36V O/P 12V / 1.25A			
PSD-15B-24	I/P 18-36V O/P 24V / 0.6A			
PSD-15C-5	I/P 36-72V O/P 5V / 3.0A		-	101.6 x 50.8 x 30
PSD-15C-12	I/P 36-72V O/P 12V / 1.25A			
PSD-15C-24	I/P 36-72V O/P 24V / 0.6A			
PSD-30A-05	I/P 9-18V O/P 5V / 5.0A			
PSD-30A-12	I/P 9-18V O/P 12V / 2.5A			
PSD-30A-24	I/P 9-18V O/P 24V / 1.25A			
PSD-30B-05	I/P 18-36V O/P 5V / 5.0A			
PSD-30B-12	I/P 18-36V O/P 12V / 2.5A			
PSD-30B-24	I/P 18-36V O/P 24V / 1.25A			
PSD-30C-05	I/P 36-72V O/P 5V / 5.0A			
PSD-30C-12	I/P 36-72V O/P 12V / 2.5A			
PSD-30C-24	I/P 36-72V O/P 24V / 1.25A			

PSD-45A-05	I/P 9.2-18V O/P 5V / 6.0A		-	127 x 76 x 30
PSD-45A-12	I/P 9.2-18V O/P 12V / 2.5A			
PSD-45A-24	I/P 9.2-18V O/P 24V / 1.25A			
PSD-45B-05	I/P 18-36V O/P 5V / 9.0A			
PSD-45B-12	I/P 18-36V O/P 12V / 3.75A			
PSD-45B-24	I/P 18-36V O/P 24V / 1.875A			
PSD-45C-05	I/P 37-72V O/P 5V / 9.0A			
PSD-45C-12	I/P 37-72V O/P 12V / 3.75A			
PSD-45C-24	I/P 37-72V O/P 24V / 1.875A			

Enclosed DC-DC Converter

Model	Output	Case	Weight	Dimensions
SD-15A-5	I/P 9.2-18V O/P 5V / 3.0A		0.18Kg	79 x 51 x 28
SD-15A-12	I/P 9.2-18V O/P 12V / 1.25A			
SD-15A-24	I/P 9.2-18V O/P 24V / 0.625A			
SD-15B-5	I/P 18-36V O/P 5V / 3.0A		0.38Kg	99 x 97 x 36
SD-15B-12	I/P 18-36V O/P 12V / 1.25A			
SD-15B-24	I/P 18-36V O/P 24V / 0.625A			
SD-15C-5	I/P 36-72V O/P 5V / 3.0A		0.53Kg	159 x 97 x 38
SD-15C-12	I/P 36-72V O/P 12V / 1.25A			
SD-15C-24	I/P 36-72V O/P 24V / 0.625A			
SD-25A-5	I/P 9.2-18V O/P 5V / 5.0A		0.65Kg	199 x 98 x 38
SD-25A-12	I/P 9.2-18V O/P 12V / 2.1A			
SD-25A-24	I/P 9.2-18V O/P 24V / 1.1A			
SD-25B-5	I/P 19-36V O/P 5V / 5.0A		0.65Kg	199 x 98 x 38
SD-25B-12	I/P 19-36V O/P 12V / 2.1A			
SD-25B-24	I/P 19-36V O/P 24V / 1.1A			
SD-25C-5	I/P 36-72V O/P 5V / 5.0A		0.65Kg	199 x 98 x 38
SD-25C-12	I/P 36-72V O/P 12V / 2.1A			
SD-25C-24	I/P 36-72V O/P 24V / 1.1A			
SD-50A-5	I/P 9.2-18V O/P 5V / 10.0A		0.65Kg	199 x 98 x 38
SD-50A-12	I/P 9.2-18V O/P 12V / 4.2A			
SD-50A-24	I/P 9.2-18V O/P 24V / 2.1A			
SD-50B-5	I/P 19-36V O/P 5V / 10.0A		0.65Kg	199 x 98 x 38
SD-50B-12	I/P 19-36V O/P 12V / 4.2A			
SD-50B-24	I/P 19-36V O/P 24V / 2.1A			
SD-50C-5	I/P 36-72V O/P 5V / 10.0A		0.65Kg	199 x 98 x 38
SD-50C-12	I/P 36-72V O/P 12V / 4.2A			
SD-50C-24	I/P 36-72V O/P 24V / 2.1A			
SD-100B-5	I/P 19-36V O/P 5V / 20.0A		0.65Kg	199 x 98 x 38
SD-100B-12	I/P 19-36V O/P 12V / 8.5A			
SD-100B-24	I/P 19-36V O/P 24V / 4.2A			
SD-100C-5	I/P 36-72V O/P 5V / 20.0A		0.65Kg	199 x 98 x 38
SD-100C-12	I/P 36-72V O/P 12V / 8.5A			
SD-100C-24	I/P 36-72V O/P 24V / 4.2A			
SD-100D-5	I/P 72-144V O/P 5V / 20.0A		0.65Kg	199 x 98 x 38
SD-100D-12	I/P 72-144V O/P 12V / 8.5A			
SD-100D-24	I/P 72-144V O/P 24V / 4.2A			

SD-150B-12	I/P 19-36V O/P 12V / 12.5A		0.86Kg	199 x 110 x 50
SD-150B-24	I/P 19-36V O/P 24V / 6.3A			
SD-150C-12	I/P 36-72V O/P 12V / 12.5A			
SD-150C-24	I/P 36-72V O/P 24V / 6.3A			
SD-150D-12	I/P 72-144V O/P 12V / 12.5A		1.1Kg	215 x 115 x 50
SD-150D-24	I/P 72-144V O/P 24V / 6.3A			
SD-200B-5	I/P 19-36V O/P 5V / 34.0A			
SD-200B-12	I/P 19-36V O/P 12V / 16.7A			
SD-200B-24	I/P 19-36V O/P 24V / 8.4A		1.1Kg	215 x 115 x 50
SD-200B-48	I/P 19-36V O/P 48V / 4.2A			
SD-200C-5	I/P 36-72V O/P 5V / 40.0A			
SD-200C-12	I/P 36-72V O/P 12V / 16.7A			
SD-200C-24	I/P 36-72V O/P 24V / 8.4A		1.1Kg	215 x 115 x 50
SD-200C-48	I/P 36-72V O/P 48V / 4.2A			
SD-200D-5	I/P 72-144V O/P 5V / 40.0A			
SD-200D-12	I/P 72-144V O/P 12V / 16.7A			
SD-200D-24	I/P 72-144V O/P 24V / 8.4A		1.1Kg	215 x 115 x 50
SD-200D-48	I/P 72-144V O/P 48V / 4.2A			
SD-350B-5	I/P 19-36V O/P 5V / 57.0A			
SD-350B-12	I/P 19-36V O/P 12V / 27.5A			
SD-350B-24	I/P 19-36V O/P 24V / 14.6A		1.1Kg	215 x 115 x 50
SD-350B-48	I/P 19-36V O/P 48V / 7.3A			
SD-350C-5	I/P 36-72V O/P 5V / 60.0A			
SD-350C-12	I/P 36-72V O/P 12V / 27.5A			
SD-350C-24	I/P 36-72V O/P 24V / 14.6A		1.1Kg	215 x 115 x 50
SD-350C-48	I/P 36-72V O/P 48V / 7.3A			
SD-350D-5	I/P 72-144V O/P 5V / 60.0A			
SD-350D-12	I/P 72-144V O/P 12V / 29.2A			
SD-350D-24	I/P 72-144V O/P 24V / 14.6A		1.15Kg	215 x 115 x 50mm
SD-350D-48	I/P 72-144V O/P 48V / 7.3A			
SD-500L-12	I/P 19-72V O/P 12V / 40.0A			
SD-500L-24	I/P 19-72V O/P 24V / 21.0A			
SD-500L-48	I/P 19-72V O/P 48V / 10.5A		1.15Kg	215 x 115 x 50mm
SD-500H-12	I/P 72-144V O/P 12V / 40.0A			
SD-500H-24	I/P 72-144V O/P 24V / 21.0A			
SD-500H-48	I/P 72-144V O/P 48V / 10.5A			
SD-1000L-12	I/P 19-72V O/P 12V / 60.0A		1.95Kg	295 x 127 x 41
SD-1000L-24	I/P 19-72V O/P 24V / 40.0A			
SD-1000L-48	I/P 19-72V O/P 48V / 21.0A			
SD-1000H-12	I/P 72-144V O/P 12V / 60.0A			
SD-1000H-24	I/P 72-144V O/P 24V / 40.0A		1.95Kg	295 x 127 x 41
SD-1000H-48	I/P 72-144V O/P 48V / 21.0A			

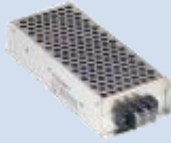
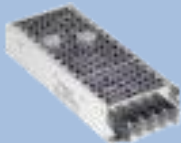
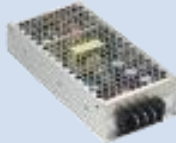
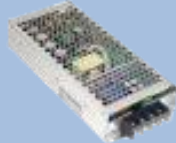
Railway (EN50155) Enclosed DC-DC Converter				
Model	Output	Case	Weight	Dimensions
RSD-100B-5 RSD-100B-12 RSD-100B-24	I/P 14.4-33.6V O/P 5V / 20.0A I/P 14.4-33.6V O/P 12V / 8.4A I/P 14.4-33.6V O/P 24V / 4.2A		0.6Kg	161 x 68 x 36
RSD-100C-5 RSD-100C-12 RSD-100C-24	I/P 28.8-67.2V O/P 5V / 20.0A I/P 28.8-67.2V O/P 12V / 8.4A I/P 28.8-67.2V O/P 24V / 4.2A			
RSD-100D-5 RSD-100D-12 RSD-100D-24	I/P 57.6-154V O/P 5V / 20.0A I/P 57.6-154V O/P 12V / 8.4A I/P 57.6-154V O/P 24V / 4.2A			
RSD-150B-5 RSD-150B-12 RSD-150B-24	I/P 14.4-33.6V O/P 5V / 30.0A I/P 14.4-33.6V O/P 12V / 12.5A I/P 14.4-33.6V O/P 24V / 6.3A		0.8Kg	189 x 77 x 36
RSD-150C-5 RSD-150C-12 RSD-150C-24	I/P 28.8-67.2V O/P 5V / 3 0.0A I/P 28.8-67.2V O/P 12V / 12.5A I/P 28.8-67.2V O/P 24V / 6.3A			
RSD-150D-5 RSD-150D-12 RSD-150D-24	I/P 57.6-154V O/P 5V / 30.0A I/P 57.6-154V O/P 12V / 12.5A I/P 57.6-154V O/P 24V / 6.3A			
RSD-200B-12 RSD-200B-24 RSD-200B-48	I/P 14.4-33.6V O/P 12V / 16.7A I/P 14.4-33.6V O/P 24V / 8.4A I/P 14.4-33.6V O/P 48V / 4.2A		0.94Kg	191 x 86 x 40
RSD-200C-12 RSD-200C-24 RSD-200C-48	I/P 28.8-67.2V O/P 12V / 16.7A I/P 28.8-67.2V O/P 24V / 8.4A I/P 28.8-67.2V O/P 48V / 4.2A			
RSD-200D-12 RSD-200D-24 RSD-200D-48	I/P 57.6-154V O/P 12V / 16.7A I/P 57.6-154V O/P 24V / 8.4A I/P 57.6-154V O/P 48V / 4.2A			
RSD-300B-5 RSD-300B-12 RSD-300B-24 RSD-300B-48	I/P 14.4-33.6V O/P 12V / 42A I/P 14.4-33.6V O/P 12V / 22.5A I/P 14.4-33.6V O/P 24V / 11.3A I/P 14.4-33.6V O/P 48V / 5.7A		1.19Kg	216 x 97 x 40
RSD-300C-5 RSD-300C-12 RSD-300C-24 RSD-300C-48	I/P 28.8-67.2V O/P 12V / 42A I/P 28.8-67.2V O/P 12V / 25A I/P 28.8-67.2V O/P 24V / 12.5A I/P 28.8-67.2V O/P 48V / 6.3A			
RSD-300D-5 RSD-300D-12 RSD-300D-24 RSD-300D-48	I/P 57.6-154V O/P 12V / 42A I/P 57.6-154V O/P 12V / 25A I/P 57.6-154V O/P 24V / 12.5A I/P 57.6-154V O/P 48V / 6.3A			





DC-AC Standalone MPPT Solar Inverter				
Model	Output	Case	Weight	Dimensions
ISI-501-212C ISI-501-224C ISI-501-248C	I/P 10.5-15.0V O/P 230V / 50Hz I/P 21.0-30.0V O/P 230V / 50Hz I/P 42.0-60.0V O/P 230V / 50Hz		2.35Kg	205 x 158 x 67 500 Watts



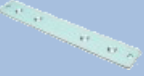

DC-AC Modified Sine Wave Inverters				
Model	Output	Case	Weight	Dimensions
A301-100-F5	I/P 10-15V O/P 230V / 50Hz		0.55Kg	170 x 65 diameter 100 watts
A302-100-F5	I/P 21-30V O/P 230V / 50Hz			
A301-150-F5	I/P 10-15V O/P 230V / 50Hz		0.80Kg	165 x 94 x 69 150 watts
A302-150-F5	I/P 21-30V O/P 230V / 50Hz			
A301-300-F5	I/P 10-15V O/P 230V / 50Hz		1.1Kg	165 x 88 x 74 300 watts
A302-300-F5	I/P 21-30V O/P 230V / 50Hz			
A301-600-F5	I/P 10-15V O/P 230V / 50Hz		2.10Kg	210 x 173 x 65 600 watts
A302-600-F5	I/P 21-30V O/P 230V / 50Hz			
A301-1K0-F5	I/P 10-15V O/P 230V / 50Hz		3.3Kg	320 x 210 x 85 1000 watts
A302-1K0-F5	I/P 21-30V O/P 230V / 50Hz			
A301-1K7-F5	I/P 10-15V O/P 230V / 50Hz		5.5Kg	455 x 210 x 85 1500 watts
A302-1K7-F5	I/P 21-30V O/P 230V / 50Hz			
A301-2K5-F5	I/P 10-15V O/P 230V / 50Hz		8.7Kg	430 x 210 x 159 2500 watts
A302-2K5-F5	I/P 21-30V O/P 230V / 50Hz			
TS-200-212 TS-200-224 TS-200-248	I/P 10.5-15V _{DC} O/P 230V / 50Hz I/P 21-30V _{DC} O/P 230V / 50Hz I/P 42-60V _{DC} O/P 230V / 50Hz		1.63Kg	205 x 158 x 59 200 watts
TS-400-212 TS-400-224 TS-400-248	I/P 10.5-15V _{DC} O/P 230V / 50Hz I/P 21-30V _{DC} O/P 230V / 50Hz I/P 42-60V _{DC} O/P 230V / 50Hz			
TS-700-212 TS-700-224 TS-700-248	I/P 10.5-15V _{DC} O/P 230V / 50Hz I/P 21-30V _{DC} O/P 230V / 50Hz I/P 42-60V _{DC} O/P 230V / 50Hz			
TS-1000-212 TS-1000-224 TS-1000-248	I/P 10.5-15V _{DC} O/P 230V / 50Hz I/P 21-30V _{DC} O/P 230V / 50Hz I/P 42-60V _{DC} O/P 230V / 50Hz		3.8Kg	295 x 184 x 70 700 watts
TS-1500-212 TS-1500-224 TS-1500-248	I/P 10.5-15V _{DC} O/P 230V / 50Hz I/P 21-30V _{DC} O/P 230V / 50Hz I/P 42-60V _{DC} O/P 230V / 50Hz			
TS-1000-212 TS-1000-224 TS-1000-248	I/P 10.5-15V _{DC} O/P 230V / 50Hz I/P 21-30V _{DC} O/P 230V / 50Hz I/P 42-60V _{DC} O/P 230V / 50Hz			
TS-1500-212 TS-1500-224 TS-1500-248	I/P 10.5-15V _{DC} O/P 230V / 50Hz I/P 21-30V _{DC} O/P 230V / 50Hz I/P 42-60V _{DC} O/P 230V / 50Hz		6.81Kg	420 x 220 x 88 1500 watts

TS-3000-212 TS-3000-224 TS-3000-248	I/P 10.5-15V _{DC} O/P 230V / 50Hz I/P 21-30V _{DC} O/P 230V / 50Hz I/P 42-60V _{DC} O/P 230V / 50Hz		12.9Kg	466.8 x 283.5 x 100 3000 watts
TN-1500-212 TN-1500-224 TN-1500-248	I/P 10.5-15V _{DC} O/P 230V / 50Hz I/P 21-30V _{DC} O/P 230V / 50Hz I/P 42-60V _{DC} O/P 230V / 50Hz		6.85Kg	420 x 220 x 88 1500 watts with Solar Input & Battery Charger
IRC1 IRC2 IRC3	IRC1: Inverter Remote Control IRC2: Inverter Remote Control IRC3: Inverter Remote Control		-	75 x 55 x 21 For TN / TS series

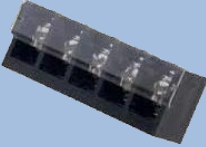
Power Source Linear AC-AC Power Supplies				
Model	Output	Case	Weight	Dimensions
PS-200-24V	24VAC / 50Hz 5 to 25VAC / 1.5A		-	(Adjustable Output)
PS-200-240V	240VAC / 50Hz 5 to 25VAC / 1.5A			

Mounting Options For Power Supplies		
Model	Description	Case
DRL-01	DIN Rail "L" Bracket c/- screws suitable for case 903, 905, 931, 932, 971	
DRL-02	DIN Rail "L" Bracket c/- screws suitable for power supply 901, 902, 906, 915, 916, 920	
DRL-03 DRL-03A	DIN Rail "L" Bracket c/- screws suitable for power supply 980, 987	
DRP-01	DIN Rail Mounting Plate c/- screws suitable for power supply cases 901, 902, 903, 911, 912, 931 & 932	
DRP-01A	DIN Rail Mounting Plate c/- screws suitable for power supply cases 203, 205, 978, 999	
DRP-02	DIN Rail Mounting Clip (large) c/- screws suitable for cases 905, 915, 916, 920, 928	
DRP-03	DIN Rail Mounting Clip (small) c/- screws suitable for DRL01, DRL-02 and DRL-03 brackets	
DRP-04	DIN Rail Mounting Clip (large) c/- screws suitable for power supply cases 230, 205, 978, 999	
MHS-012	"L" Mounting Feet (small) c/- screws suitable for power supply SP-320, SP- 100, SP-150, SP-240, HRP-300/600, RSP-2400/3000...	
MHS-013	"L" Mounting Feet (large) c/- screws suitable for power supply PSP-500, SP- 750	

MHS-014	"L" Mounting Feet c/- screws suitable for power supply RSP-1000, SD-1000	
MHS-025	Straight Mounting Feet c/- screws suitable for power supply SP-500, PSP- 600...	
MHS-026	"L" Mounting Feet c/- screws suitable for power supply RSP-1500	
MHS-027	Straight Mounting Feet c/- screws suitable for power supply RS-15, RS-25	
YP35 + YC12	Mains IEC Cable 3-pin AU plug + IEC320-C13 inlet Weight: 0.2Kg	
TBC-05	Terminal block cover for 5 pole	
TBC-07	Terminal block cover for 7 pole	
TBC-08	Terminal block cover for 8 pole	
TBC-09	Terminal block cover for 9 pole	

AC/DC Power Supplies				
Model	Output	Case	Weight	Dimensions
LPL-18-12 LPL-18-24 LPL-18-36	12V / 1.5A 24V / 0.75A 36V / 0.5A		-	140 x 30 x 22
LPH-18-36	36V / 0.5A			
LPV-20-5 LPV-20-15	5V / 3.0A 15V / 1.33A		-	118 x 35 x 26
PLN-20-24	24V / 0.8A		-	148.5 x 38.5 x 28
ELN-30-5 ELN-30-9 ELN-30-15 ELN-30-27 ELN-30-48	5V / 5.0A 9V / 3.4A 15V / 2.0A 27V / 1.12A 48V / 0.63A		0.26Kg	145 x 47 x 30 D : 1.1 - 10V _{DC} external dimming P : PWM control dimming
ELN-30-9D ELN-30-12D ELN-30-15D ELN-30-27D	9V / 3.4A 12V / 2.5A 15V / 2.0A 27V / 1.12A			
ELN-30-9P ELN-30-12P ELN-30-15P ELN-30-27P	9V / 3.4A 12V / 2.5A 15V / 2.0A 27V / 1.12A			
PLC-45-24	24V / 1.9A			

PLN-45-15 PLN-45-24 PLN-45-27 PLN-45-48	15V / 3.0A 24V / 1.9A 27V / 1.7A 48V / 0.95A		-	181 x 61.5 x 35
CEN-60-24 CEN-60-48	24V / 2.5A 48V / 1.3A		-	185 x 62.5 x 40.5
ELN-60-9 ELN-60-27 ELN-60-48	9V / 5.0A 27V / 2.3A 48V / 1.3A		0.4Kg	181 x 61.5 x 35 D : 1.1 - 10V _{DC} external dimming P : PWM control dimming
ELN-60-9D ELN-60-15D	9V / 5.0A 15V / 4.0A			
ELN-60-9P ELN-60-15P	9V / 5.0A 15V / 4.0A			
LPV-60-15 LPV-60-24 LPV-60-36 LPV-60-48	15V / 8.0A 24V / 2.5A 36V / 1.67A 48V / 1.25A			
PLC-60-24	24V / 2.5A		0.41Kg	181.5 x 62 x 35
CEN-75-48	48V / 1.57A		-	185 x 62.5 x 40.5
CEN-100-24 CEN-100-48	24V / 4.0A 48V / 2.0A		-	195 x 62.5 x 40.5
SPU15A-110	36V / 410mA		-	-
ES18B07-P1J	7.5V / 2.0A		220g	79 x 54 x 33
P66A-1-1R1B P66A-4P2J	7.5V / 6.40A 15V / 4.40A		0.55Kg	147x 75.5 x 43.2

For all enquiries, please contact the sale department at:

admin@alphapower.com.au

or call us on 02 9602 8331

